



**TARIFA DE PRECIOS**

**Hispanox 2007**

**Tornillería acero inoxidable**





---

Can Magí, 20

---

Polígono Industrial Santiga

---

Apartado de Correos 364

---

08210 Barberà del Vallès

---

Barcelona - España

---

Tel. 93 729 99 60

---

Fax. 93 729 99 61

---

[hispanox@hispanox.com](mailto:hispanox@hispanox.com)

---

[comercial@hispanox.com](mailto:comercial@hispanox.com)

---

[www.hispanox.com](http://www.hispanox.com)

---



**HISPANOX** es en la actualidad una empresa líder en la distribución de tornillería en acero inoxidable tanto en piezas normalizadas como en especiales. Alcanzar esta posición no hubiera sido posible sin la confianza que nos han depositado nuestros clientes durante muchos años. Nuestra filosofía como empresa ha estado siempre centrada en unos conceptos fundamentales que marca nuestra gestión diaria en todos los ámbitos de nuestra organización:

**Confianza:** nuestro objetivo siempre ha sido ganarnos la confianza de nuestros clientes a través de la seriedad en el trato personal y el cumplimiento escrupuloso de nuestros compromisos.

**Profesionalidad:** disponemos de una organización y de un equipo de profesionales que nos distingue en nuestro servicio y atención al cliente.

**Seguridad:** las 10.000 referencias en stock permanente, las amplias instalaciones y nuestros medios logísticos nos permiten ofrecer una seguridad en el suministro de los pedidos y una rapidez en la entrega de sólo 24 horas.

Esperamos que este catálogo les sea útil y seguir disfrutando de su confianza en el futuro.



**HISPANOX** is currently a leading company in distributing stainless steel nuts and bolts in standard and special pieces, and it would not have been possible to reach this position without the confidence our customers have placed in us for many years.

Our philosophy as a company has always focused on the fundamental concepts that mark our daily management on all levels of the organization:

**Confidence:** our aim has always been to gain the confidence of our customers through serious personal dealings and the scrupulous fulfilment of our commitments.

**Professionalism:** we have an organization and a team of professionals enabling us to stand out in our service and customer attention.

**Security:** through the 10.000 references in permanent stock, our broad facilities and our logistic means, we offer security in the supply of all orders and delivery in only 24 hours.

We hope to continue to count on your confidence in the future.







### AMPLIA GAMA DE PRODUCTOS

Stock permanente de más de 10.000 artículos diferentes.

Broad product range: permanent stock of over 10.000 different articles.

### SERVICIO DE ENTREGA INMEDIATO

Rapidez en el suministro. Entrega en sólo 24 horas.

Immediate delivery: speed in delivery. Delivery in just 24 hours.

### ATENCIÓN AL CLIENTE

Equipo de profesionales a su disposición ofreciéndole asesoramiento y respuestas inmediatas a sus consultas.

Customer attention: a team of professionals at your disposal offering you advice and immediate replies.

**BUREAU VERITAS**  
Certification



## Certificación

Concedida a

**HISPANOX, S.A.**

BARCELONA

C/ CAN MAGÍ 20, POL. IND. SANTIGA, 08210, BARBERÀ DEL VALLÈS,

Bureau Veritas certifica que el Sistema de Gestión de dicha Organización ha sido auditado y encontrado conforme con las exigencias de la norma:

NORMA

**ISO 9001:2000**

El Sistema de Gestión se aplica a:

COMERCIALIZACIÓN DE TORNILLERÍA Y ELEMENTOS DE FIJACIÓN.

Fecha de emisión inicial: **10 julio 2000**

Siempre que se mantengan las condiciones de aplicación del Sistema de Gestión, este certificado es válido hasta el **24 octubre 2009**

Para comprobar la validez del certificado puede llamar al teléfono (91 270 22 00)

Para cualquier información sobre el alcance del certificado y la aplicación de los requisitos del Sistema de Gestión pueden ponerse en contacto con la organización.

Número del Certificado: 6002913

Fecha

03 noviembre 2006

Oficina Coordinadora: BUREAU VERITAS CERTIFICATION ESPAÑA  
Oficina Ejecutora: BUREAU VERITAS CERTIFICATION ESPAÑA  
Francisco Delgado, S.  
Parque Empresarial Arroyo de la Yega,  
28048 Alcorcón Madrid









**ENAC**  
CERTIFICACIÓN  
Nº 04/C-3004



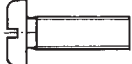
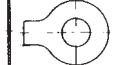
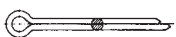
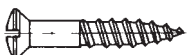
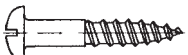
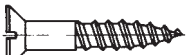







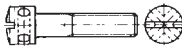

**HISPANOX:** Ha obtenido la CERTIFICACIÓN ISO 9001:2000 otorgada por BUREAU VERITAS Certification. Este Certificado, reconocimiento a la madurez y eficacia de nuestro sistema de calidad, confirma nuestra voluntad de desarrollarnos en una línea de progreso continuo para dar cada día una respuesta más ajustada a las necesidades de nuestros Clientes.



# GAMA DE PRODUCTOS

## INDEX IN NORM ORDER

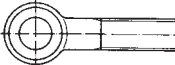
DIN	ARTÍCULO - ARTICLE	PÁGINA - PAGE		
		A2	A4	Acero
1		1		
7		2		
84		3	145	
85		4	146	
93		5	147	
94		6	148	
95		7	149	
96		8	150	
97		9	151	
125		10	152	
127		11	153	
128		12	154	
137A		13		
137B		14		
315		15	155	

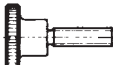







DIN	ARTÍCULO - ARTICLE	PÁGINA - PAGE		
		A2	A4	Acero
316		16		
404		17		
431		18		
432		19		
433		20	156	
434		21		
435		21		
436		22		
439		23	157	
439 Paso fino		24	158	
440R		25	159	
440v		25	159	
444		26	160	
463		27	161	
464		28		





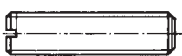
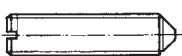
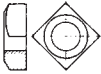
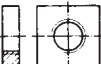

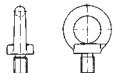
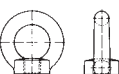
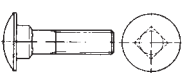
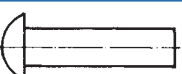
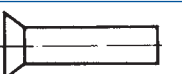
Les ofrecemos la posibilidad de suministrarles todo tipo de pieza especial bajo plano o muestra

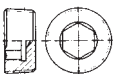
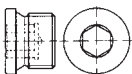
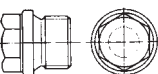
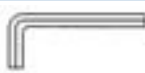
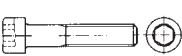

# GAMA DE PRODUCTOS

## INDEX IN NORM ORDER

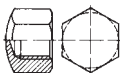
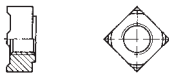
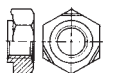

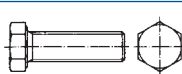
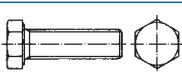





DIN	ARTÍCULO - ARTICLE	PÁGINA - PAGE		
		A2	A4	Acero
466		29		
467		30		
471		32		227
472		34		230
551		36		
553		37		
557		38	162	
562		38	162	
571		39	163	217
580		40		
582		41		
603		42	164	
660		43		
661		44		
705		45		

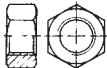
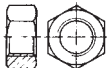
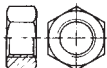
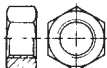
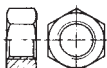
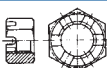

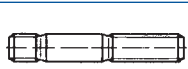
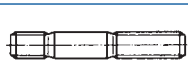

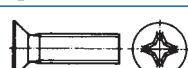



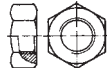
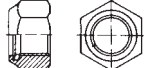
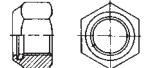
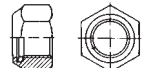

DIN	ARTÍCULO - ARTICLE	PÁGINA - PAGE		
		A2	A4	Acero
906		46		218 219 Latón
908		47		220
910		48		221
911				222
912		50	166	
913		52	168	223
914		53	169	224
915		54	170	225
916		55	171	226
917		56	172	
928		57	173	
929		57	173	
931		58	174	
933		60	176	
933 UNC-W		63	179	

Les ofrecemos la posibilidad de suministrarles todo tipo de pieza especial bajo plano o muestra

# GAMA DE PRODUCTOS

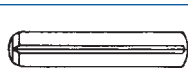
## INDEX IN NORM ORDER

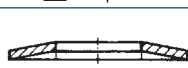
DIN	ARTÍCULO - ARTICLE	PÁGINA - PAGE		
		A2	A4	Acero
934		64	180	
934 Rosca izquierda		65	181	
934 Paso fino		66	182	
934 UNC		67	183	
934 w		68	184	
935		69		
936		70	185	
938		71		
939		72		
963		73	186	
964		74	187	
965		75	188	
966		76	189	
975 UNC-W		77	190	
975		78	191	











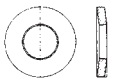

DIN	ARTÍCULO - ARTICLE	PÁGINA - PAGE		
		A2	A4	Acero
980		79	192	
982		80	193	
985		81	194	
985 UNC		82		
985 w		82		
986		83		
1440		84	195	
1441		85	196	
1471		86		
1473		87		
1481		88		
1587		89	197	
2093		90		
6330		91		
6331		91		

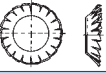
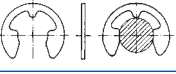

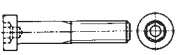

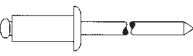



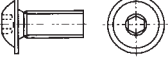

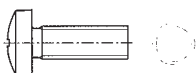

Les ofrecemos la posibilidad de suministrarles todo tipo de pieza especial bajo plano o muestra

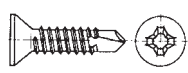
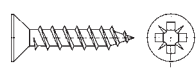
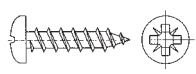

# GAMA DE PRODUCTOS

## INDEX IN NORM ORDER

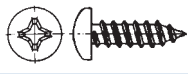
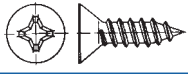
DIN	ARTÍCULO - ARTICLE	PÁGINA - PAGE		
		A2	A4	Acero
6796		92	198	
6797A		93		
6797J		93		
6798A		94	199	
6798J		94	199	
6798V		94		
6799		95		233
6885			200	
6912		96	202	
6923		97	203	
7337A		98		
7343		99		
7349		100		
7380		101		
7380 FL		102		





DIN	ARTÍCULO - ARTICLE	PÁGINA - PAGE		
		A2	A4	Acero
7500c		103		
7500M		104		
7504K		105		
7504N		106		
7504P		107		
7505A		108		
7505B		109		
7971		110	204	
7972		111	205	
7973		112	206	
7976		113		
7980		114	207	
7981		115	208	
7982		116	209	
7983		117	210	

Les ofrecemos la posibilidad de suministrarles todo tipo de pieza especial bajo plano o muestra

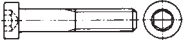
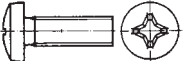

# GAMA DE PRODUCTOS

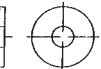
## INDEX IN NORM ORDER

DIN	ARTÍCULO - ARTICLE	PÁGINA - PAGE		
		A2	A4	Acero
7984		118	211	
7985		119	212	
7991		120	213	
7997		121		
9021		122	214	
NFE 25-511		123		

Les ofrecemos la posibilidad de suministrarles todo tipo de pieza especial bajo plano o muestra











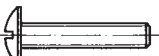



















**Hispanox s.a.**

Tel. 93 729 99 60 - Fax 93 729 99 61

# GAMA DE PRODUCTOS

## INDEX IN NORM ORDER

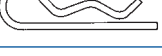
HX	ARTÍCULO - ARTICLE	PÁGINA - PAGE		
		A2	A4	Acero
10004		124		
10007		125		
10009		126		
10010		127		
10011		128		
10012		129		
10018		130	215	
10019		130	215	
10020		131		
10021		132		
10026		133		
10028		135		
10042		135		
10031		136		
10032		137		
10033		137		

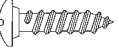
HX	ARTÍCULO - ARTICLE	PÁGINA - PAGE		
		A2	A4	Acero
10034		138		
10035		138		
10036		139		
10037		139		
10038		140		
10039		140		
10040		141		
10041		141		
10043		142		
10044		142		
10045		143		
10046		144		
10056		134		
10057		134		
10058		31		
10066				222

Les ofrecemos la posibilidad de suministrarles todo tipo de pieza especial bajo plano o muestra

# INFORMACIÓN TÉCNICA

## CARACTERÍSTICAS MECÁNICAS DE LOS TORNILLOS

Grupo	Calidad del producto	Clase de resistencia	Límites de los diámetros de rosca	Resistencia a la tracción $R_m^{1)}$ mín. N/mm <sup>2</sup>	Límite elástico convencional al 0,2% $R_{p0,2}^{1)}$ mín. N/mm <sup>2</sup>	Alargamiento de rotura a $A_L$ mín.mm
Austenítico	A1, A2 y A4	50	≤ M 39	500	210	0,6 d
		70	≤ M 24	700	450	0,4 d
		80	≤ M 24	800	600	0,3 d

1) La resistencia a la tracción se calcula en función de la sección resistente de la rosca

## CARACTERÍSTICAS MECÁNICAS DE LAS TUERCAS

Grupo	Calidad del producto	Clase de resistencia	Límites de los diámetros de rosca d mm	Resistencia a la carga de prueba, $s_p$ mín. N/mm <sup>2</sup> Tuerca de tipo 1 ( $m \geq 0,8d$ )
Austenítico	A1, A2 y A4	50	≤ M 39	500
		70	≤ M 24	700
		80	≤ M 24	800

Calidad del producto	Composición química % <sup>1)</sup>								
	C	Si	Mn	P	S	Cr	Mo	Ni	Cu
A1	0,12	1	6,5	0,2	0,15 - 0,35	16 a 19	0,7	5 a 10	1,75 a 2,25
A2	0,1	1	2	0,05	0,03	15 a 20		8 a 19	4
A4	0,08	1	2	0,045	0,03	16 a 18,5	2 a 3	10 a 15	1

1) Los valores indicados son máximos.

- Los aceros de calidad A1 se destinan especialmente al mecanizado. Debido a su alto contenido en azufre esta clase de aceros tienen una menor resistencia a la corrosión.

- Los aceros inoxidables austeníticos normalmente suelen ser no magnéticos, sin embargo después de una deformación en frío puede detectarse un ligero magnetismo. Esto no modifica de manera significativa las características de inoxidabilidad de estos aceros.

- Asimismo los aceros inoxidables para muelles pasan a ser magnéticos durante la deformación en frío, debido a que parte de la austenita se ha transformado en martensita, que es magnética. Cuanto mayor sea la dureza, mayor porcentaje de martensita obtendremos y por lo tanto mayor será su magnetismo.

# PASOS DE ROSCA

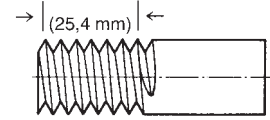
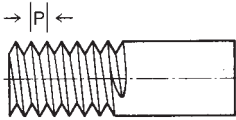

Métrica	Paso normal	Paso fino			UNC/UNF Nr	Pulgadas	=m/m	PASO (hilos por pulgada)				
								UNC	UNF	BSW	BSF	BSP GAS
1	0,25	(0,2)			0		1,524	-	80	-	-	
1,2	0,25	(0,2)			1		1,854	64	72	-	-	
1,4	0,3	(0,2)			2		2,184	56	64	-	-	
1,6	0,35	(0,2)			3		2,515	48	56	-	-	
1,8	0,35	(0,2)			4		2,845	40	48	-	-	
2	0,4	(0,25)			5		3,175	40	44	-	-	
2,2	0,45	(0,25)			6		3,505	32	40	-	-	
2,5	0,45	(0,35)			8		4,166	32	36	-	-	
3	0,5	(0,35)			10		4,826	24	32	-	-	
3,5	0,6	(0,35)			12		5,486	24	28	-	-	
4	0,7	0,5				1/8	3,175	40	44	40	-	28
5	0,8	0,5				5/32	3,969	32	36	32	-	
6	1	0,75	0,5			3/16	4,763	24	32	24	32	
7	1	0,75	0,5			7/32	5,556	24	28	24	28	
8	1,25	1	0,75	0,5		1/4	6,350	20	28	20	26	19
10	1,5	1,25	1	0,75		5/16	7,938	18	24	18	22	
12	1,75	1,5	1,25	1		3/8	9,525	16	24	16	20	19
14	2	1,5	1,25	1		7/16	11,113	14	20	14	18	
16	2	1,5		1		1/2	12,700	13	20	12	16	14
18	2,5	2	1,5	1		9/16	14,288	12	18	12	16	
20	2,5	2	1,5	1		5/8	15,875	11	18	11	14	14
22	2,5	2	1,5	1		3/4	19,050	10	16	10	12	14
24	3	2	1,5	1		7/8	22,225	9	14	9	11	14
27	3	2	1,5	(1)		1	25,401	8	12	8	10	11
30	3,5	2	1,5	(1)		1 1/8	28,575	7*	12	7	9	11
33	3,5	2	1,5			1 1/4	31,750	7*	12	7	9	11
36	4	3	2	1,5		1 3/8	34,925	6*	12	6	8	11
39	4	3	2	1,5		1 1/2	38,100	6*	12	6	8	11
42	4,5	(4) 3	2	1,5		1 3/4	44,450	5*	12	5	7	11
45	4,5	(4) 3		1,5		2	50,802	4 1/2*	12	4 1/2	7	11
48	5	(4) 3	2	1,5								
52	5	(4) 3	2	1,5								
56	5,5	4	3/2	1,5								
60	5,5	4	3/2	1,5								
64	6	4	3	2 (1,5)								
68	6	4	3	2 (1,5)								
							Ángulo de rosca	60°		55°		



# VALORES ORIENTATIVOS DEL PAR DE APRIETE, LÍMITE DE RUPTURA Y LÍMITE ELÁSTICO

	Clase de Resistencia	M 3	M 4	M 5	M 6	M 8	M 10	M 12
Par de apriete Nm	80	1,2	2,7	5,4	9,3	22	44	76
	70	0,9	2,1	4,1	7,1	17,5	34	59
	50	0,4	1	1,9	3,3	7,8	15	27
Límite de ruptura kN	80	4	7	11,3	16,1	29,2	46,4	67,4
	70	3,5	6,1	9,9	14	25,6	40,6	59
	50	2,5	4,4	7,1	10	18,3	29	42,1
Límite elástico kN	80	3	5,3	8,5	12,1	21,9	34,8	50,4
	70	2,2	3,9	6,4	9	16,4	26,1	37,9
	50	1,1	1,9	2,9	4,2	7,7	12,2	17,6
Sección de resistencia mm <sup>2</sup>		5,0	8,8	14,2	20,1	36,6	58	84

	Clase de Resistencia	M 14	M 16	M 20	M 24	M 27	M 30	
Par de apriete Nm	80	121	187	364	659	909	1240	
	70	91	140	273	472	682	930	
	50	43	65	127	220	318	434	
Límite de ruptura kN	80	92	125,6	196	282,4	367,2	448,8	
	70	80,5	109,9	171,5	247,1	321,3	392,7	
	50	57,5	78,5	122,5	176,5	229,5	280,5	
Límite elástico kN	80	69	94,2	147	211,8	275,4	336,6	
	70	51,8	70,6	110,2	158,8	206,6	252,5	
	50	24,1	32,9	51,4	74,1	96,4	117,8	
Sección de resistencia mm <sup>2</sup>		115	157	245	353	459	561	

# TABLAS DE CORROSIÓN

AGENTE DE CORROSIÓN	RESISTENCIA A LA CORROSIÓN	
	AISI 304	AISI 316
Aceites comestibles	buena	buena
Acetona	buena	buena
Ácido bórico	buena	buena
Ácido cianhídrico	buena	buena
Ácido cítrico	buena	buena
Ácido clorhídrico	mala	mala
Ácido fluorhídrico	mala	mala
Ácido fosfórico	buena	buena
Ácido láctico	buena	buena
Ácido nítrico	buena	buena
Ácido oxálico	buena	buena
Ácido salicílico	buena	buena
Ácido sulfúrico	mala	buena
Agua de mar	regular	buena
Agua oxigenada	buena	buena
Agua potable	buena	buena
Agua regia	mala	mala
Alcohol etílico	buena	buena
Alcohol metílico	buena	buena
Amoníaco	buena	buena
Atmósfera marina	regular	buena
Azúcar en solución y jarabes	buena	buena
Cloro	regular	regular
Cloruro sódico	regular	buena

AGENTE DE CORROSIÓN	RESISTENCIA A LA CORROSIÓN	
	AISI 304	AISI 316
Colas	buena	buena
Eter	buena	buena
Gasolina	buena	buena
Glicerina	buena	buena
Jabones	buena	buena
Jugos de limón y de naranja	buena	buena
Jugo de tomate	regular	buena
Leche	buena	buena
Leche fermentada	buena	buena
Licores	buena	buena
Parafina	buena	buena
Petróleo	buena	buena
Sangre	buena	buena
Sidra	buena	buena
Sosa cáustica	buena	buena
Taninos	buena	buena
Tintas	buena	buena
Tricloroetileno	buena	buena
Vino	buena	buena

## PASADOR CONICO TAPER PINS

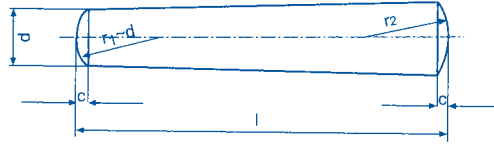

<b>c</b>	0,12	0,2	0,25	0,3	0,4	0,5	0,63	0,8	1	1,2
<b>r1</b>	1	1,5	2	2,5	3	4	5	6	8	10

<b>d</b> $\varnothing$	<b>1</b>	<b>1,5</b>	<b>2</b>	<b>2,5</b>	<b>3</b>	<b>4</b>	<b>5</b>	<b>6</b>	<b>8</b>	<b>10</b>
<b>L 8</b>	96,76	127								
<b>10</b>	96,76	80,93	82,69							
<b>12</b>	104	80,93	84,45							
<b>14</b>	116	91,49	96,76	137	111					
<b>16</b>	116	91,49	96,76	100	116	241	229			
<b>18</b>	116	100	106	111	130	183	252			
<b>20</b>		107	113	120	150	206	271			
<b>22</b>		114	120	128	167	227	297			
<b>24</b>		120	123	143	179	248	317	389		
<b>26</b>		120	127	157	195	267	336	412		
<b>28</b>			160	160	206	280	359	435	686	
<b>30</b>			172	167	225	301	382	457	800	
<b>32</b>			179	179	236	320	405	480	892	1.189
<b>36</b>			183	190	245	357	435	519	983	1.258
<b>40</b>				199	264	389	480	572	1.075	1.372
<b>45</b>					281	424	503	640	1.166	1.418
<b>50</b>					297	456	538	709	1.281	1.510
<b>55</b>						493	572	778	1.395	1.715
<b>60</b>						554	618	823	1.510	1.830
<b>70</b>							686	892	1.647	1.967
<b>80</b>								983	1.830	2.173
<b>90</b>								1.121	2.013	2.401
<b>100</b>								1.281	2.173	2.630

Precios en € por 100 unidades. Medidas indicadas en m/m

## PASADOR CILINDRICO CYLINDRICAL PINS



(Tolerancia  $d = m_6$ )

<b>c</b>	0,15	0,23	0,3	0,4	0,45	0,6	0,75	0,9	1,2	1,5	1,8
<b>r</b>	1	1,5	2	2,5	3	4	5	6	8	10	12

<b>d</b>	<b>g</b>	<b>1</b>	<b>1,5</b>	<b>2</b>	<b>2,5</b>	<b>3</b>	<b>4</b>	<b>5</b>	<b>6</b>	<b>8</b>	<b>10</b>	<b>12</b>
<b>L</b>	<b>3</b>	29,73	34,31	34,31								
	<b>4</b>	29,73	34,31	34,31	38,71	38,71						
	<b>5</b>	29,73	34,31	34,31	38,71	38,71	58,06					
	<b>6</b>	29,73	34,31	34,31	42,22	42,22	59,82	72,13				
	<b>8</b>	32,02	42,22	42,22	49,26	49,26	68,61	82,69	114			
	<b>10</b>	32,02	42,22	42,22	49,26	49,26	80,93	96,76	128	206	304	609
	<b>12</b>	32,02	42,22	42,22	54,54	54,54	91,49	106	137	220	343	477
	<b>14</b>	36,95	45,74	45,74	61,58	61,58	100	121	153	241	378	549
	<b>16</b>	42,22	49,26	49,26	72,13	72,13	114	127	165	264	412	595
	<b>18</b>	45,74	52,78	52,78	77,41	77,41	123	137	188	290	447	653
	<b>20</b>	51,02	54,54	54,54	82,69	82,69	130	146	204	320	470	705
	<b>24</b>		54,54	54,54	87,97	87,97	144	165	218	343	538	769
	<b>28</b>		72,13	72,13	120	120	165	188	241	389	618	846
	<b>30</b>		84,45	84,45	135	135	169	202	257	406	656	939
	<b>32</b>		87,97	87,97	143	143	172	206	264	412	663	961
	<b>36</b>				183	183	206	227	297	457	732	1.064
	<b>40</b>						220	248	333	526	800	1.166
	<b>45</b>						236	267	366	595	1.006	1.316
	<b>50</b>						252	274	389	595	1.006	1.418
	<b>55</b>								445	720	1.078	1.615
	<b>60</b>								457	732	1.098	1.647
	<b>70</b>								584	823	1.327	1.967
	<b>80</b>								709	915	1.487	2.241
	<b>90</b>								769	1.013	1.647	2.401
	<b>100</b>										1.784	2.699

Precios en € por 100 unidades. Medidas indicadas en m/m



## TORNILLO CABEZA CILINDRICA SLOTTED CHEESE HEAD SCREWS

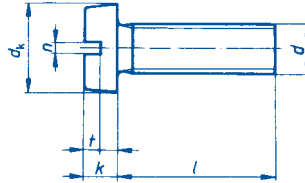

<b>t min.</b>	0,45	0,6	0,7	0,85	1	1,1	1,3	1,6	2	2,4
<b>n</b>	0,4	0,5	0,6	0,8	1	1,2	1,2	1,6	2	2,5
<b>k</b>	1	1,3	1,6	2	2,4	2,6	3,3	3,9	5	6
<b>dk</b>	3	3,8	4,5	5,5	6	7	8,5	10	13	16

<b>d</b>	<b>M-1,6</b>	<b>M-2</b>	<b>M-2,5</b>	<b>M-3</b>	<b>M-3,5</b>	<b>M-4</b>	<b>M-5</b>	<b>M-6</b>	<b>M-8</b>	<b>M-10</b>
<b>L 3</b>	65,10	17,07	17,07	8,60						
<b>4</b>	52,78	17,07	17,07	7,74		9,30				
<b>5</b>	45,74	17,24	17,24	7,74	58,06	9,30				
<b>6</b>	51,02	17,59	17,59	5,19	58,06	6,86	15,97	24,60		
<b>8</b>	52,78	18,47	18,47	5,19	58,06	6,86	13,95	21,41		
<b>10</b>	54,54	20,23	20,23	4,75	58,06	6,44	11,08	15,13	79,35	
<b>12</b>	68,61	22,52	22,52	5,10	58,06	7,55	12,14	16,10	52,59	
<b>14</b>	87,97	35,19	35,19	8,44	95,00	12,84	19,88	25,86		
<b>16</b>	91,49	24,63	24,63	5,63	68,61	8,50	13,20	17,95	56,40	
<b>18</b>		45,74	45,74	9,32	107	14,41	21,94	28,50		
<b>20</b>		32,02	32,02	6,19	80	9,69	14,62	20,41	59,27	157
<b>22</b>		73,89	73,89	9,50	130	17,07	23,40	32,11		
<b>25</b>		42,22	42,22	7,21	104	11,37	17,01	23,22	65,98	172
<b>30</b>		68,61	68,61	8,57	116	12,98	19,25	26,21	78,40	194
<b>35</b>				15,39	162	18,16	24,10	33,08	102	220
<b>40</b>				19,18	179	21,02	26,30	36,77	111	241
<b>45</b>				43,10		26,78	37,28	43,46	121	257
<b>50</b>				53,66		31,35	41,10	49,79	133	289
<b>60</b>						38,48	62,14	67,56	166	394
<b>70</b>						48,38	95,00	101	264	514
<b>80</b>							145	163	364	640
<b>90</b>							206	230	436	690
<b>100</b>								269	523	748

Precios en € por 100 unidades. Medidas indicadas en m/m

## TORNILLO CABEZA ALOMADA SLOTTED PAN HEAD SCREWS

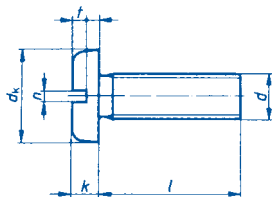

t min.	0,6	0,7	0,8	1	1,2	1,4	1,9
n	0,5	0,6	0,8	1,2	1,2	1,6	2
k	1,3	1,5	1,8	2,4	3	3,6	4,8
dk	4	5	6	8	10	12	16

d	M - 2	M - 2,5	M - 3	M - 4	M - 5	M - 6	M - 8
L 3	30,44	30,44					
4	18,30	18,30	13,56				
5	20,58	20,58	8,30	10,89			
6	21,29	21,29	7,64	9,36	18,93		
8	22,87	22,87	7,64	9,36	16,63	20,94	
10	24,10	24,10	6,88	8,50	13,37	18,74	94,65
12	27,09	27,09	7,27	9,08	14,15	19,53	63,09
16	29,38	29,38	8,13	10,22	15,96	20,27	67,88
20	35,19	36,95	9,27	11,19	17,59	22,66	71,71
25		49,26	13,56	14,15	20,46	25,72	79,35
30			15,68	16,82	23,89	28,68	93,70
35			25,81	20,07	29,63	42,07	123
40			34,41	25,81	33,46	48,75	133
45			49,72	47,80	44,93	63,09	146
50			60,22	55,45	49,72	80,31	159
60					75,53	97,52	199
70					139	172	317
80					174	220	436
90					225	243	535
100					289	285	644

Precios en € por 100 unidades. Medidas indicadas en m/m







## TORNILLO ROSCA MADERA CABEZA GOTA DE SEBO SLOTTED RAISED COUNTERSUNK HEAD WOOD SCREW

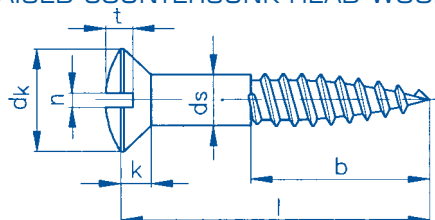

$h \geq 0,6 L$

tmax.	1,2	1,45	1,7	1,9	2,1	2,3	2,5	2,8	3,7
n	0,6	0,8	0,8	1	1	1,2	1,2	1,6	2
f≈	0,6	0,75	0,9	1	1,1	1,25	1,4	1,5	2
k	1,5	1,65	1,93	2,2	2,35	2,5	2,75	3	4
dk	4,7	5,6	6,5	7,5	8,3	9,2	10,2	11	14,5

nº	17	18	19	20	21	22	23	24	27
ds	2,5	3	3,5	4	4,5	5	5,5	6	8
L 10	19,56								
12	19,56	19,56	20,46						
16	18,10	18,10	18,75	25,86	32,02				
20	18,75	18,75	20,06	23,28	32,34	37,51			
25	21,34	21,34	23,28	25,86	34,92	40,10	56,91	56,91	
30	28,45	28,45	29,75	32,34	37,51	42,68	63,37	63,37	445
35		31,03	32,34	34,92	40,10	46,57	68,56	68,56	445
40		35,19	37,51	40,10	46,57	49,16	75,02	75,02	470
45			45,74	47,85	51,74	56,91	85,36	85,36	514
50			51,02	53,03	56,91	64,67	94,42	94,42	537
60				84,45	97,01	102	119	119	633
65						129	135	135	
70					128	140	160	160	730
80						208	246	246	834
90							398	398	945
100							505	505	1.050
110									1.256
120									1.379

Precios en € por 100 unidades. Medidas indicadas en m/m



## TORNILLO ROSCA MADERA CABEZA REDONDA SLOTTED ROUND HEAD WOOD SCREWS

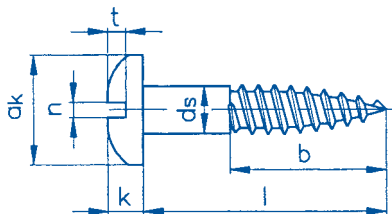

$h \geq 0,6 L$

t max.	1,1	1,35	1,6	1,8	2	2,3	2,5	2,7	3,6
n	0,6	0,8	0,8	1	1	1,2	1,2	1,6	2
K	1,7	2,1	2,4	2,8	3,1	3,5	3,8	4,2	5,6
dk	5	6	7	8	9	10	11	12	16

nº	17	18	19	20	21	22	23	24	27
ds	2,5	3	3,5	4	4,5	5	5,5	6	8
L 10	19,56								
12	19,56	19,56	20,46						
16	18,10	18,10	18,75	25,86	32,02				
20	18,75	18,75	20,06	23,28	32,34	37,51			
25	21,34	21,34	23,28	25,86	34,92	40,10	56,91	56,91	
30	28,45	28,45	29,75	32,34	37,51	42,68	63,37	63,37	443
35		31,03	32,34	34,92	40,10	46,57	68,56	68,56	443
40		35,19	37,51	40,10	46,57	49,16	75,02	75,02	470
45			45,74	47,85	51,74	56,91	85,36	85,36	512
50			51,02	53,03	56,91	64,67	94,42	94,42	537
60				84,45	97,01	102	119	119	633
65						139	135	135	
70					128	140	160	160	730
80						208	246	246	834
90							398	398	945
100							505	505	1.050
110									1.256
120									1.379

Precios en € por 100 unidades. Medidas indicadas en m/m

## TORNILLO ROSCA MADERA CABEZA PLANA SLOTTED COUNTERSUNK HEAD WOOD SCREWS

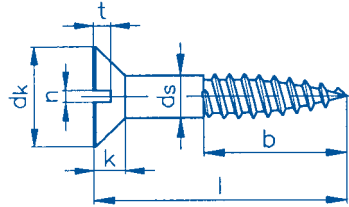

$h \geq 0,6 L$

<b>t max.</b>	0,7	0,85	1	1,1	1,2	1,3	1,4	1,6	2,1
<b>n</b>	0,6	0,8	0,8	1	1	1,2	1,2	1,6	2
<b>K</b>	1,5	1,65	1,93	2,2	2,35	2,5	2,75	3	4
<b>dk</b>	4,7	5,6	6,5	7,5	8,3	9,2	10,2	11	14,5

<b>nº</b>	17	18	19	20	21	22	23	24	27
<b>ds</b>	2,5	3	3,5	4	4,5	5	5,5	6	8
<b>L 10</b>	13,90								
<b>12</b>	13,90	14,46	15,13						
<b>16</b>	13,37	13,37	13,86	19,11	23,66				
<b>20</b>	13,86	13,86	14,81	17,21	23,89	27,73			
<b>25</b>	15,76	15,76	17,21	19,11	25,81	29,63	42,07	42,07	
<b>30</b>	21,02	21,02	21,99	23,89	27,73	31,54	46,85	46,85	445
<b>35</b>		22,94	23,89	25,81	29,63	34,41	50,67	50,67	445
<b>40</b>		27,45	27,73	29,63	34,41	36,33	55,45	55,45	470
<b>45</b>			35,19	35,36	38,23	42,07	63,09	63,09	512
<b>50</b>			38,71	39,20	42,07	47,80	69,79	69,79	535
<b>60</b>				68,61	71,71	75,53	87,97	87,97	633
<b>65</b>						103	100	100	
<b>70</b>					104	107	120	120	730
<b>80</b>						169	183	183	832
<b>90</b>						294	324	324	945
<b>100</b>						373	420	420	1.050
<b>110</b>								565	1.256
<b>120</b>								607	1.379

Precios en € por 100 unidades. Medidas indicadas en m/m



## ARANDELA PLANA WASHERS

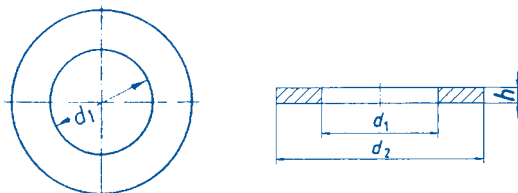

M	d <sub>1</sub>	d <sub>2</sub>	h	PRECIO
1,6	1,7	4	0,3	18,65
2	2,2	5	0,3	2,90
2,5	2,7	6,5	0,5	2,90
3	3,2	7	0,5	0,95
3,5	3,7	8	0,5	4,50
4	4,3	9	0,8	1,06
5	5,3	10	1	1,41
6	6,4	12	1,6	2,48
7	7,4	14	1,6	9,70
8	8,4	16	1,6	3,99
10	10,5	20	2	8,02
12	13	24	2,5	13,49
14	15	28	2,5	21,99
16	17	30	3	24,98
18	19	34	3	34,83
20	21	37	3	38,18
22	23	39	3	50,84
24	25	44	4	79,52
27	28	50	4	133
30	31	56	4	188
33	34	60	5	373
36	37	66	5	586
39	40	72	6	954
42	43	78	7	1.485
45	46	85	7	2.780
48	50	92	8	3.603
50	52	92	8	4.641
52	54	98	8	4.894

Precios en € por 100 unidades. Medidas indicadas en m/m

## ARANDELA GROWER FORMA B SPRING LOCK WASHERS

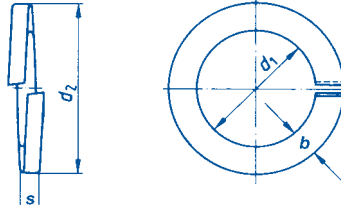

M	d <sub>1</sub>	d <sub>2</sub>	b	s	PRECIO
2	2,1	4,4	0,9	0,5	3,10
2,5	2,6	5,1	1	0,6	3,10
3	3,1	6,2	1,3	0,8	1,14
3,5	3,6	6,7	1,3	0,8	4,70
4	4,1	7,6	1,5	0,9	1,27
5	5,1	9,2	1,8	1,2	1,72
6	6,1	11,8	2,5	1,6	2,92
7	7,1	12,8	2,5	1,6	4,75
8	8,1	14,8	3	2	4,75
10	10,2	18,1	3,5	2,2	7,16
12	12,2	21,1	4	2,5	11,44
14	14,2	24,1	4,5	3	18,47
16	16,2	27,4	5	3,5	26,46
18	18,2	29,4	5	3,5	31,84
20	20,2	33,6	6	4	45,57
22	22,5	35,9	6	4	55,42
24	24,5	40	7	5	85,68
27	27,5	43	7	5	146
30	30,5	48,2	8	6	206
33	33,5	55,2	10	6	1.126
36	36,5	58,2	10	6	1.905
39	39,5	61,2	10	6	4.368
42	42,5	68,2	12	7	6.541
45	45,5	71,2	12	7	8.128
48	49	75	12	7	9.289

Precios en € por 100 unidades. Medidas indicadas en m/m

## ARANDELA DE MUELLE ABOMBADA FORMA A SPRING WASHERS, HEAVY DUTY

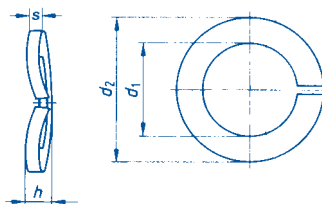

M	d <sub>1</sub>	d <sub>2</sub>	s	h min.	h max.	PRECIO
2	2,1	4,4	0,5	0,7	0,9	9,68
2,5	2,6	5,1	0,6	0,9	1,1	9,68
3	3,1	6,2	0,7	1,1	1,3	5,81
3,5	3,6	6,7	0,7	1,1	1,3	7,57
4	4,1	7,6	0,8	1,2	1,4	8,09
5	5,1	9,2	1	1,5	1,7	8,09
6	6,1	11,8	1,3	2	2,2	16,01
8	8,2	14,8	1,6	2,45	2,75	32,02
10	10,2	18,1	1,8	2,85	3,15	45,74
12	12,2	21,1	2,1	3,35	3,65	72,13
14	14,2	24,1	2,4	3,9	4,3	89,73
16	16,2	27,4	2,8	4,5	5,1	127
18	18,2	29,4	2,8	4,5	5,1	143
20	20,2	33,6	3,2	5,1	5,9	209
22	22,5	35,9	3,2	5,1	5,9	225
24	24,5	40	4	6,5	7,5	318

Precios en € por 100 unidades. Medidas indicadas en m/m

# DIN 137-A

ACERO INOXIDABLE - STAINLESS STEEL

**A2**  
aisi 304

## ARANDELA DE MUELLE CURVADA FORMA A CURVED SPRING WASHERS

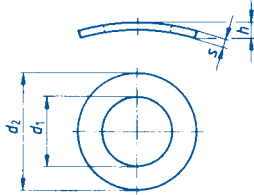

M	d <sub>1</sub>	d <sub>2</sub>	s	h min.	h max.	PRECIO
1,6	1,8	4	0,25	0,45	0,9	12,32
2	2,2	4,5	0,3	0,5	1	8,44
2,5	2,8	5,5	0,3	0,55	1,1	8,44
3	3,2	6	0,4	0,65	1,3	7,04
3,5	3,7	7	0,4	0,7	1,4	12,84
4	4,3	8	0,5	0,8	1,6	7,92
5	5,3	10	0,5	0,9	1,8	11,44
6	6,4	11	0,5	1,1	2,2	12,67
7	7,4	12	0,5	1,2	2,4	21,11
8	8,4	15	0,5	1,7	3,4	28,68
10	10,5	18	0,8	2	4	63,34

Precios en € por 100 unidades. Medidas indicadas en m/m

**ARANDELA DE MUELLE ONDULADA FORMA B**  
**WAVE SPRING WASHERS**

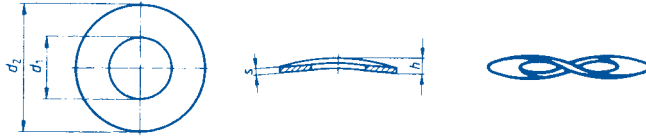

M	d <sub>1</sub>	d <sub>2</sub>	s	h min.	h max.	PRECIO
3	3,2	8	0,5	0,8	1,6	7,04
3,5	3,7	8	0,5	0,9	1,8	12,84
4	4,3	9	0,5	1	2	7,92
5	5,3	11	0,5	1,1	2,2	11,44
6	6,4	12	0,5	1,3	2,6	12,67
7	7,4	14	0,8	1,5	3	21,11
8	8,4	15	0,8	1,5	3	28,68
10	10,5	21	1	2,1	4,2	63,34
12	13	24	1,2	2,5	5	96,76
14	15	28	1,6	3	6	172
16	17	30	1,6	3,2	6,4	197
18	19	34	1,6	3,3	6,6	257
20	21	36	1,6	3,7	7,4	325
22	23	40	1,8	3,9	7,8	428
24	25	44	1,8	4,1	8,2	486

Precios en € por 100 unidades. Medidas indicadas en m/m



### TUERCA MARIPOSA TIPO AMERICANO

WING NUTS, AMERICAN TYPE

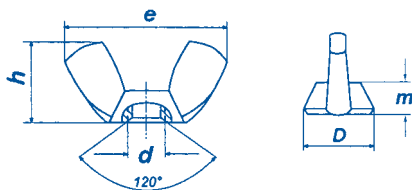

d	e	D	h	m	PRECIO
M-3	17,6	7,8	8,6	2,9	77,45
M-4	17,6	7,8	8,6	2,9	77,45
M-5	22	9,5	10,5	4	69,79
M-6	27	11,9	13	5	83,18
M-8	30,3	13,5	14,8	5,4	147
M-10	35,5	15,3	17,3	6,3	215
M-12	47,5	20,5	22,1	8	429
M-14	66	25,5	30,8	10,6	1.395
M-16	66	25,5	30,8	10,6	2.007
M-20	66,5	29,3	31,2	12,2	3.088

Precios en € por 100 unidades. Medidas indicadas en m/m

## TORNILLO DE MARIPOSA TIPO AMERICANO WING SCREWS, AMERICAN TYPE

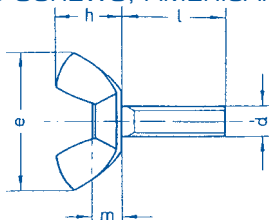

<b>h</b>	8,8	10,5	10,5	12,9	14,8	17,3	22,3
<b>e</b>	18,5	22	22	26,8	30,3	35,3	47,5
<b>m</b>	2,9	2,9	4,1	5,1	5,6	6,8	9

<b>d</b>	<b>M-3</b>	<b>M-4</b>	<b>M-5</b>	<b>M-6</b>	<b>M-8</b>	<b>M-10</b>	<b>M-12</b>
<b>L 10</b>	366	366	378	526			
<b>12</b>	366	366	378	526			
<b>16</b>	366	366	378	526	823	961	
<b>20</b>	378	378	412	561	823	961	1.921
<b>25</b>	389	389	424	584	846	1.029	1.990
<b>30</b>	401	401	435	595	859	1.121	2.036
<b>35</b>		401	447	618	927	1.166	2.104
<b>40</b>		412	480	640	938	1.235	2.150
<b>45</b>			561	755	1.098	1.281	2.196
<b>50</b>			732	869	1.133	1.327	2.264
<b>55</b>					1.189	1.349	2.333
<b>60</b>					1.327	1.349	2.401

Precios en € por 100 unidades. Medidas indicadas en m/m

# DIN 404

ACERO INOXIDABLE - STAINLESS STEEL

**A2**  
aisi 304

## TORNILLO DE AGUJEROS CRUZADOS SLOTTED CAPSTAN SCREWS

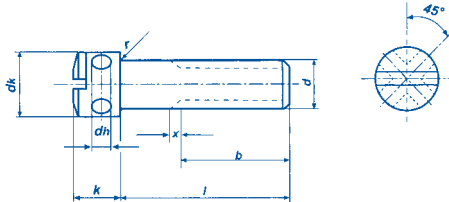

$d_h$	1,5	2	2,5	3
b	19	22	25	28
k	4	5	6,5	8
$d_k$	5,5	7	8,5	10

d	M-3	M-4	M-5	M-6
L 4	640			
5	653	721		
6	663	732		
8	686	755	1.052	
10	709	816	1.075	2.087
12	732	843	1.098	2.176
16	744	913	1.121	2.257
20	755	976	1.133	2.407
25		1.033	1.189	2.502
30		1.073	1.235	2.565

Precios en € por 100 unidades. Medidas indicadas en m/m



Hispanox s.a.

Tel. 93 729 99 60 - Fax 93 729 99 61

## TUERCA ROSCA GAS PIPE NUTS

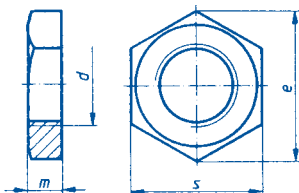

d	nº hilos x pulgada	m	s	e	PRECIO
G 1/8	28	6	19	20,88	320
G 1/4	19	6	22	23,91	389
G 3/8	19	7	27	29,56	630
G 1/2	14	8	32	35,03	1.006
G 5/8	14	8	32	35,03	1.052
G 3/4	14	9	36	39,55	1.395
G 7/8	14	9	41	45,2	1.898
G 1	11	10	46	50,85	2.401
G 1 1/4	11	11	55	60,79	2.973
G 1 1/2	11	12	60	66,44	4.117
G 2	11	13	75	82,6	5.947

Precios en € por 100 unidades. Medidas indicadas en m/m

## ARANDELA DE SEGURIDAD CON PESTAÑA WASHERS WITH EXTERNAL TAB

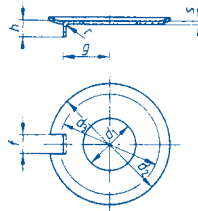

M	d <sub>1</sub>	d <sub>2</sub>	s	f	g	h	PRECIO
4	4,3	14	0,4	2,5	5,5	2	333
5	5,3	17	0,75	3,5	7	2,5	355
6	6,4	19	0,75	3,5	7,5	3	343
8	8,4	22	1	3,5	8,5	4	366
10	10,5	26	1	4,5	10	4	457
12	13	30	1,2	4,5	12	4,5	607
14	15	33	1,2	4,5	13	4,5	686
16	17	36	1,2	5,5	15	4,5	823
18	19	40	1,2	6,5	18	4,5	961
20	21	42	1,6	6,5	18	4,5	1.006
22	23	50	1,6	7,5	20	6,5	1.316
24	25	50	1,6	7,5	21	6,5	1.316
27	28	58	1,6	8,5	23	9,5	1.898
30	31	63	1,6	8,5	25	9,5	2.630
33	34	68	1,6	9,5	28	9,5	3.316
36	37	75	2	11	31	9,5	3.728
39	40	82	2	11	33	11	4.117

Precios en € por 100 unidades. Medidas indicadas en m/m

## ARANDELA PARA TORNILLOS CABEZA CILÍNDRICA WASHERS FOR CHEESE HEAD SCREWS

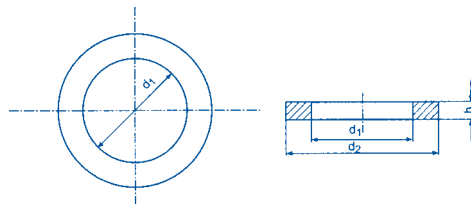

M	$d_1$	$d_2$	h	PRECIO
1,6	1,7	3,5	0,3	16,54
2	2,2	4,5	0,3	16,54
2,5	2,7	5	0,5	16,54
3	3,2	6	0,5	3,69
3,5	3,7	7	0,5	7,39
4	4,3	8	0,5	4,40
5	5,3	9	1	5,98
6	6,4	11	1,6	9,68
8	8,4	15	1,6	17,24
10	10,5	18	1,6	28,85
12	13	20	2	49,26
14	15	24	2,5	98,52
16	17	28	2,5	111
18	19	30	2,5	171
20	21	34	3	188

Precios en € por 100 unidades. Medidas indicadas en m/m

## ARANDELAS CUADRADAS EN CUÑA SQUARE TAPER WASHERS

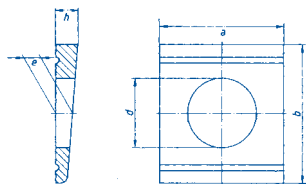

### DIN 434 para perfiles "U" ◀ 8%

M	d	a	b	e	h	PRECIO
M-8	9	22	22	2,9	3,8	892
M-10	11	22	22	2,9	3,8	892
M-12	14	26	30	3,7	4,9	1.499
M-16	18	32	36	4,45	5,9	1.728
M-20	22	40	44	5,25	7	2.299
M-22	24	44	50	6	8	4.573
M-24	26	56	56	6,26	8,5	5.135

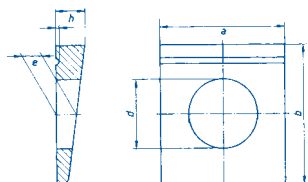

### DIN 435 para perfiles "I" ◀ 14%

M	d	a	b	e	h	PRECIO
M-8	9	22	22	3,05	4,6	1.532
M-10	11	22	22	3,05	4,6	1.532
M-12	14	26	30	4,1	6,2	2.173
M-16	18	32	36	5	7,5	2.493
M-20	22	40	44	6,1	9,2	3.431
M-22	24	44	50	6,5	10	4.803
M-24	26	56	56	6,9	10,8	6.290

Precios en € por 100 unidades. Medidas indicadas en m/m



## ARANDELA PLANA PARA CONSTRUCCIONES MADERA SQUARE WASHERS FOR WOOD CONSTRUCTIONS

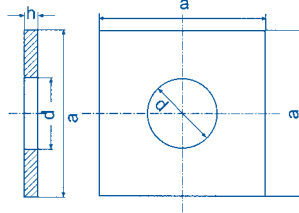

M	d	a	h	PRECIO
M-10	11	30	3	325
M-12	14	40	4	515
M-16	18	50	5	781
M-20	22	60	5	1.119
M-22	24	70	6	1.538
M-24	26	80	6	1.882

Precios en € por 100 unidades. Medidas indicadas en m/m



## TUERCA EXAGONAL BAJA HEXAGON THIN NUTS

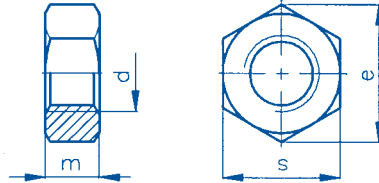

d	s	e	m	PRECIO
M-1,6	3,2	3,48	1	61,58
M-2	4	4,32	1,2	36,95
M-2,5	5	5,45	1,6	35,19
M-3	5,5	6,01	1,8	6,16
M-4	7	7,66	2,2	6,81
M-5	8	8,79	2,7	8,13
M-6	10	11,05	3,2	9,68
M-8	13	14,38	4	18,37
M-10	17	18,9	5	43,54
M-12	19	21,1	6	57,62
M-14	22	24,49	7	176
M-16	24	26,75	8	192
M-18	27	29,56	9	547
M-20	30	32,95	10	647
M-22	32	35,03	11	1.209
M-24	36	39,55	12	1.648
M-27	41	45,2	13,5	2.127
M-30	46	50,85	15	2.963
M-33	50	55,37	16,5	4.163
M-36	55	60,79	18	6.084
M-39	60	66,44	19,5	6.633
M-42	65	71,3	21	8.348
M-45	70	76,95	22,5	10.429
M-48	75	82,6	24	11.471

Precios en € por 100 unidades. Medidas indicadas en m/m



## TUERCA EXAGONAL BAJA PASO FINO HEXAGON THIN NUTS, FINE PITCH THREAD

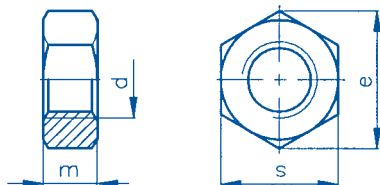

M	s	e	m	PRECIO
8 x 0,75	13	14,38	4	329
8 x 1	13	14,38	4	113
10 x 1	17	18,90	5	202
10 x 1,25	17	18,90	5	239
12 x 1	19	21,10	6	403
12 x 1,25	19	21,10	6	403
12 x 1,5	19	21,10	6	290
14 x 1,5	22	24,49	7	401
16 x 1,5	24	26,75	8	549
18 x 1,5	27	29,56	9	676
20 x 1,5	30	32,95	10	973
20 x 2	30	32,95	10	1.110
22 x 1,5	32	35,03	11	1.166
22 x 2	32	35,03	11	1.166
24 x 1,5	36	39,55	12	1.555
24 x 2	36	39,55	12	1.555
27 x 1,5	41	45,20	13,50	2.058
27 x 2	41	45,20	13,50	2.058
30 x 1,5	46	50,85	15	3.042
30 x 2	46	50,85	15	3.042
33 x 2	50	55,37	16,50	4.771

Precios en € por 100 unidades. Medidas indicadas en m/m

## ARANDELA PLANA PARA CONSTRUCCIONES MADERA WASHERS, ESPECIALLY FOR WOOD CONSTRUCTIONS

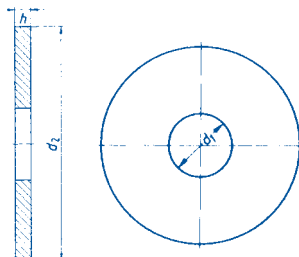

### DIN 440-R

M	d <sub>1</sub>	d <sub>2</sub>	h	PRECIO
M-5	5,5	18	2	82,69
M-6	6,6	22	2	114
M-8	9	28	3	294
M-10	11	34	3	408
M-12	14	44	4	869
M-16	18	56	5	1.590
M-20	22	72	6	2.150
M-22	24	80	6	2.516
M-24	26	85	6	2.790

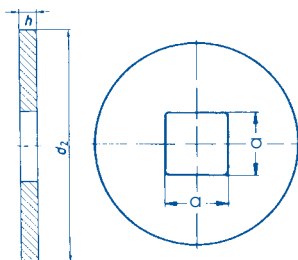

### DIN 440-V

M	a	d <sub>2</sub>	h	PRECIO
M-5	5,5	18	2	508
M-6	6,6	22	2	804
M-8	9	28	3	1.166
M-10	11	34	3	1.738
M-12	14	44	4	2.127
M-16	18	56	5	3.042
M-20	22	72	6	3.820
M-24	26	85	6	4.947

Precios en € por 100 unidades. Medidas indicadas en m/m



### TORNILLOS CON OJO FORMA B

#### EYE BOLTS FORM B

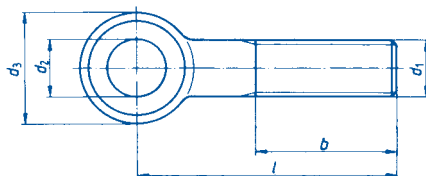
①  $L \leq 125$  mm②  $125$  mm  $< L \leq 200$  mm

$h$ ①	18	22	26	30	38	46	54
$h$ ②		28	32	36	44	52	60
$d_2$	6	8	10	12	16	18	22
$d_3$	14	18	20	25	32	40	45

$d_1$	M-6	M-8	M-10	M-12	M-16	M-20	M-24
L 30	823	1.075					
35	859	1.133					
40	892	1.202	1.464				
45	938	1.279	1.647				
50	1.006	1.372	1.751	2.356			
55	1.075	1.418	1.828	2.437			
60	1.121	1.441	1.921	2.493	3.659		
65		1.499	2.036	2.516	3.774		
70		1.532	2.131	2.516	3.943	6.061	
75		1.601	2.196	2.630	4.231	6.061	
80		1.624	2.231	2.813	4.391	6.061	7.662
90		1.777	2.277	2.972	4.551	6.610	8.005
100		1.995	2.482	3.264	4.643	6.884	8.371
110			2.699	3.591	4.757	7.308	8.737
120			2.859	3.688	4.917	7.410	9.034
130				5.215	5.146	7.593	9.263
140				5.250	5.329	7.799	9.789
150				5.345	5.466	8.234	10.063

Precios en € por 100 unidades. Medidas indicadas en m/m

## ARANDELA DE SEGURIDAD CON DOS SOLAPAS TAB WASHERS WITH TWO TABS

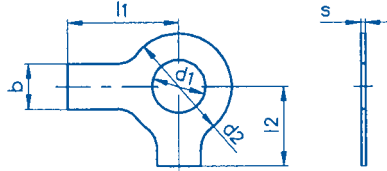

para Tornillo	$d_1$	$d_2$	$l_1$	$l_2$	$b$	$s$	PRECIO
M-4	4,3	9	14	6,5	5	0,4	306
M-5	5,3	10	16	8	6	0,5	310
M-6	6,4	12,5	18	9	7	0,5	318
M-8	8,4	17	20	11	8	0,75	366
M-10	10,5	21	22	13	10	0,75	480
M-12	13	24	28	15	12	1	618
M-14	15	28	28	16	12	1	709
M-16	17	30	32	18	15	1	755
M-18	19	34	36	20	18	1	1.052
M-20	21	37	36	21	18	1	1.098
M-22	23	39	42	23	20	1	1.304
M-24	25	44	42	25	20	1	1.395
M-27	28	50	48	29	23	1,6	2.493
M-30	31	56	52	32	26	1,6	2.539
M-33	34	60	56	34	28	1,6	3.065
M-36	37	66	60	38	30	1,6	3.659
M-39	40	72	64	41	32	1,6	3.888

Precios en € por 100 unidades. Medidas indicadas en m/m

## TORNILLO MOLETEADO FORMA ALTA

KNURLED THUMB SCREWS, HIGH TYPE

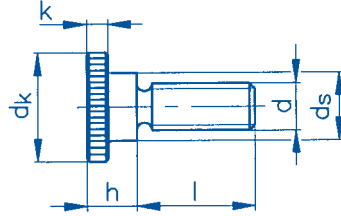

<b>K</b>	2,5	3,5	4	5
<b>h</b>	7,5	9,5	11,5	15
<b>d<sub>s</sub></b>	6	8	10	12
<b>d<sub>K</sub></b>	12	16	20	24

<b>d</b>	<b>M-3</b>	<b>M-4</b>	<b>M-5</b>	<b>M-6</b>
<b>L 4</b>	538			
<b>5</b>	561	732		
<b>6</b>	595	767	1.773	
<b>8</b>	640	1.006	1.819	
<b>10</b>	686	1.029	1.875	2.173
<b>12</b>	744	1.110	1.921	2.264
<b>16</b>	823	1.144	1.944	2.493
<b>20</b>	913	1.258	1.990	2.734

Precios en € por 100 unidades. Medidas indicadas en m/m

### TUERCA MOLETEADA FORMA ALTA KNURLED THUMB NUTS, HIGH TYPE

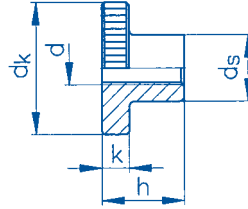

d	d <sub>k</sub>	d <sub>s</sub> max.	h max.	K max.	PRECIO
M-2	9	4,5	5,3	2	572
M-2,5	11	5	6,5	2,5	607
M-3	12	6	7,5	2,5	378
M-4	16	8	9,5	3,5	470
M-5	20	10	11,5	4	616
M-6	24	12	15	5	938
M-8	30	16	18	6	1.705
M-10	36	20	23	8	2.950

Precios en € por 100 unidades. Medidas indicadas en m/m

**TUERCA MOLETEADA FORMA BAJA**  
KNURLED THUMB NUTS, THIN TYPE

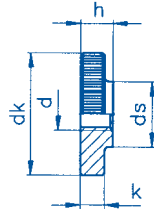

d	dk	dk max.	h max.	K max.	PRECIO
M-2	9	4,5	2,5	2	526
M-2,5	11	5	3	2,5	572
M-3	12	6	3	2,5	333
M-4	16	8	4	3,5	412
M-5	20	10	5	4	572
M-6	24	12	6	5	890
M-8	30	16	8	6	1.532
M-10	36	20	10	8	2.653

Precios en € por 100 unidades. Medidas indicadas en m/m



## TORNILLO ROSCA CHAPA - ENVOLVENTE - SELF TAPPING SCREWS

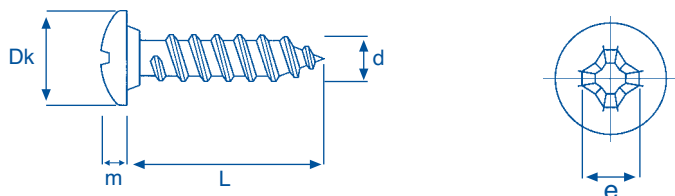

dK	10	10
m	2,3	2,3
e	4,6	4,6

	4,8	5,5
L 13	40,11	
16	44,16	
19	49,79	68,97
22	53,48	76,36
25	58,23	83,57
32	68,97	100
38	80,40	116
50	111	153
60		172
70		217

Precios en € por 100 unidades. Medidas indicadas en m/m

## ANILLO DE SEGURIDAD EXTERIOR RETAINING RINGS FOR SHAFTS

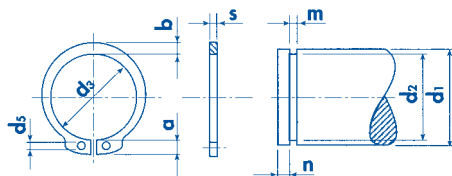

Medida Nominal Ø EJE D1	anillo de seguridad					Ranura alojamiento anillo			
	s	d <sub>2</sub>	d <sub>3</sub>	b ≈	a max.	d <sub>2</sub>	m (H13)	n (min.)	PRECIO
5	0,6	1	4,7	1,1	2,5	4,8	0,7	0,3	8,40
6	0,7	1,2	5,6	1,3	2,7	5,7	0,8	0,5	9,30
7	0,8	1,2	6,5	1,4	3,1	6,7	0,9	0,5	10,20
8	0,8	1,2	7,4	1,5	3,2	7,6	0,9	0,6	10,20
9	1	1,2	8,4	1,7	3,3	8,6	1,1	0,6	14,50
10	1	1,5	9,3	1,8	3,3	9,6	1,1	0,6	14,50
11	1	1,5	10,2	1,8	3,3	10,5	1,1	0,8	15,30
12	1	1,7	11	1,8	3,3	11,5	1,1	0,8	15,30
13	1	1,7	11,9	2	3,4	12,4	1,1	0,9	20,60
14	1	1,7	12,9	2,1	3,5	13,4	1,1	0,9	20,60
15	1	1,7	13,8	2,2	3,6	14,3	1,1	1,1	22,70
16	1	1,7	14,7	2,2	3,7	15,2	1,1	1,2	25,90
17	1	1,7	15,7	2,3	3,8	16,2	1,1	1,2	30,90
18	1,2	2	16,5	2,4	3,9	17	1,3	1,5	41,00
19	1,2	2	17,5	2,5	3,9	18	1,3	1,5	42,80
20	1,2	2	18,5	2,6	4	19	1,3	1,5	42,80
21	1,2	2	19,5	2,7	4,1	20	1,3	1,5	48,60
22	1,2	2	20,5	2,8	4,2	21	1,3	1,5	50,70
23	1,2	2	21,5	2,9	4,3	22	1,3	1,5	57,50
24	1,2	2	22,2	3	4,4	22,9	1,3	1,7	60,50
25	1,2	2	23,2	3	4,4	23,9	1,3	1,7	64,60
26	1,2	2	24,2	3,1	4,5	24,9	1,3	1,7	79,80
28	1,5	2	25,9	3,2	4,7	26,6	1,6	2,1	102
29	1,5	2	26,9	3,4	4,8	27,6	1,6	2,1	110
30	1,5	2	27,9	3,5	5	28,6	1,6	2,1	110
31	1,5	2,5	28,6	3,6	5,2	29,3	1,6	2,6	131
32	1,5	2,5	29,6	3,6	5,2	30,3	1,6	2,6	131
34	1,5	2,5	31,5	3,8	5,4	32,3	1,6	2,6	139

Precios en € por 100 unidades. Medidas indicadas en m/m

## ANILLO DE SEGURIDAD EXTERIOR

### RETAINING RINGS FOR SHAFTS

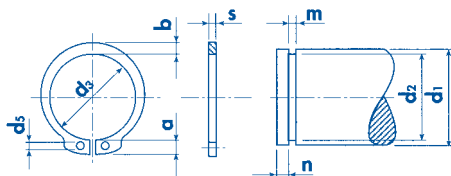

Medida Nominal Ø EJE D1	anillo de seguridad					Ranura alojamiento anillo				
	s	d <sub>5</sub>	d <sub>3</sub>	b ≈	a max.	d <sub>2</sub>	m (H13)	n (min.)	PRECIO	
35	1,5	2,5	32,2	3,9	5,6	33	1,6	3	155	
36	1,75	2,5	33,2	4	5,6	34	1,85	3	162	
38	1,75	2,5	35,2	4,2	5,9	36	1,85	3	184	
40	1,75	2,5	36,5	4,4	6	37,5	1,85	3,8	189	
42	1,75	2,5	38,5	4,5	6,5	39,5	1,85	3,8	195	
44	1,75	2,5	40,5	4,6	6,6	41,5	1,85	3,8	201	
45	1,75	2,5	41,5	4,7	6,7	42,5	1,85	3,8	201	
47	1,75	2,5	43,5	4,9	6,8	44,5	1,85	3,8	215	
48	1,75	2,5	44,5	5	6,9	45,5	1,85	3,8	215	
50	2	2,5	45,8	5,1	6,9	47	2,15	4,5	222	
52	2	2,5	47,8	5,2	7	49	2,15	4,5	228	
55	2	2,5	50,8	5,4	7,2	52	2,15	4,5	233	
56	2	2,5	51,8	5,5	7,3	53	2,15	4,5	278	
58	2	2,5	53,8	5,5	7,3	55	2,15	4,5	278	
60	2	2,5	55,8	5,8	7,4	57	2,15	4,5	278	
62	2	2,5	57,8	6	7,5	59	2,15	4,5	287	
63	2	2,5	58,8	6,2	7,6	60	2,15	4,5	366	
65	2,5	3	60,8	6,3	7,8	62	2,65	4,5	366	
68	2,5	3	63,5	6,5	8	65	2,65	4,5	512	
70	2,5	3	65,5	6,6	8,1	67	2,65	4,5	512	
75	2,5	3	70,5	7	8,4	72	2,65	4,5	586	
80	2,5	3	74,5	7,4	8,6	76,5	2,65	5,3	671	
85	3	3,5	79,5	7,8	8,7	81,5	3,15	5,3	882	
90	3	3,5	84,5	8,2	8,8	86,5	3,15	5,3	1.112	
95	3	3,5	89,5	8,6	9,4	91,5	3,15	5,3	1.226	
100	3	3,5	94,5	9	9,6	96,5	3,15	5,3	1.318	

Precios en € por 100 unidades. Medidas indicadas en m/m



## ANILLO DE SEGURIDAD INTERIOR

### RETAINING RINGS FOR BORES

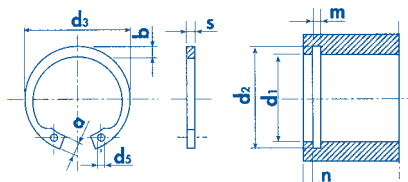

Medida Nominal Ø AGUJERO D1	anillo de seguridad					Ranura alojamiento anillo			
	s	d <sub>5</sub>	d <sub>3</sub>	b ≈	a max.	d <sub>2</sub>	m (H13)	n (min.)	PRECIO
8	0,8	1	8,7	1,1	2,4	8,4	0,9	0,6	12,90
9	0,8	1	9,8	1,3	2,5	9,4	0,9	0,6	14,80
10	1	1,2	10,8	1,4	3,2	10,4	1,1	0,6	14,80
11	1	1,2	11,8	1,5	3,3	11,4	1,1	0,6	18,60
12	1	1,5	13	1,7	3,4	12,5	1,1	0,8	18,60
13	1	1,5	14,1	1,8	3,6	13,6	1,1	0,9	19,00
14	1	1,7	15,1	1,9	3,7	14,6	1,1	0,9	19,50
15	1	1,7	16,2	2	3,7	15,7	1,1	1,1	19,50
16	1	1,7	17,3	2	3,8	16,8	1,1	1,2	20,40
17	1	1,7	18,3	2,1	3,9	17,8	1,1	1,2	22,70
18	1	2	19,5	2,2	4,1	19	1,1	1,5	23,30
19	1	2	20,5	2,2	4,1	20	1,1	1,5	24,80
20	1	2	21,5	2,3	4,2	21	1,1	1,5	27,70
21	1	2	22,5	2,4	4,2	22	1,1	1,5	30,50
22	1	2	23,5	2,5	4,2	23	1,1	1,5	33,20
23	1,2	2	24,6	2,5	4,2	24	1,3	1,7	44,30
24	1,2	2	25,9	2,6	4,4	25,2	1,3	1,8	46,70
25	1,2	2	26,9	2,7	4,5	26,2	1,3	1,8	48,80
26	1,2	2	27,9	2,8	4,7	27,2	1,3	1,8	50,40
27	1,2	2	29,9	2,9	4,7	28,2	1,3	1,8	52,10
28	1,2	2	30,1	2,9	4,8	29,4	1,3	2,1	55,40
29	1,2	2	31,1	3	4,8	30,4	1,3	2,1	60,90
30	1,2	2	32,1	3	4,8	31,4	1,3	2,1	60,90
31	1,2	2,5	33,4	3,2	5,2	32,7	1,3	2,6	65,40
32	1,2	2,5	34,4	3,2	5,2	33,7	1,3	2,6	65,40
34	1,5	2,5	36,5	3,3	5,4	35,7	1,6	2,6	83,40
35	1,5	2,5	37,8	3,3	5,4	37	1,6	3	86,90

Precios en € por 100 unidades. Medidas indicadas en m/m

## ANILLO DE SEGURIDAD INTERIOR

### RETAINING RINGS FOR BORES

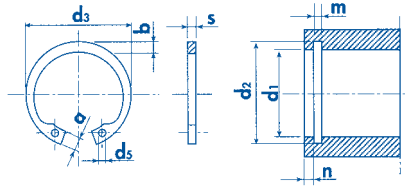

Medida nominal Ø AGUJERO D1	Anillo de seguridad					Ranura alojamiento anillo			PRECIO
	s	d <sub>2</sub>	d <sub>3</sub>	b ≈	a max.	d <sub>2</sub>	m (H13)	n (min.)	
36	1,5	2,5	38,8	3,5	5,4	38	1,6	3	99,10
37	1,5	2,5	39,8	3,6	5,5	39	1,6	3	108
38	1,5	2,5	40,8	3,7	5,5	40	1,6	3	114
40	1,75	2,5	43,5	4	5,9	42,5	1,85	3,8	139
42	1,75	2,5	45,5	4,1	5,9	44,5	1,85	3,8	148
44	1,75	2,5	47,5	4,2	6,0	46,5	1,85	3,8	172
45	1,75	2,5	48,5	4,3	6,2	47,5	1,85	3,8	172
46	1,75	2,5	49,5	4,4	6,3	48,5	1,85	3,8	181
47	1,75	2,5	50,5	4,4	6,4	49,5	1,85	3,8	181
48	1,75	2,5	51,5	4,5	6,4	50,5	1,85	3,8	189
50	2	2,5	54,2	4,6	6,5	53	2,15	4,5	189
52	2	2,5	56,2	4,7	6,7	55	2,15	4,5	197
55	2	2,5	59,2	5	6,8	58	2,15	4,5	206
56	2	2,5	61,2	5,1	6,8	59,0	2,15	4,5	221
58	2	2,5	62,2	5,2	6,9	61	2,15	4,5	221
60	2	2,5	64,2	5,4	7,3	63	2,15	4,5	234
62	2	2,5	66,2	5,5	7,3	65	2,15	4,5	242
63	2	2,5	67,2	5,6	7,3	66,0	2,15	4,5	261
65	2,5	3	69,2	5,8	7,6	68	2,65	4,5	261
68	2,5	3	72,5	6,1	7,8	71	2,65	4,5	343
70	2,5	3	74,5	6,2	7,8	73	2,65	4,5	400
72	2,5	3	76,5	6,4	7,8	75	2,65	4,5	442
75	2,5	3	79,5	6,6	7,8	78	2,65	4,5	539
80	2,5	3	85,5	7	8,5	83,5	2,65	5,3	736
85	3	3,5	90,5	7,2	8,6	88,5	3,15	5,3	1.079
90	3	3,5	95,5	7,6	8,6	93,5	3,15	5,3	1.140
95	3	3,5	100,5	8,1	8,8	98,5	3,15	5,3	1.325
100	3	3,5	105,5	8,4	9,2	103,5	3,15	5,3	1.377

Precios en € por 100 unidades. Medidas indicadas en m/m

## ESPARRAGOS RANURADOS PUNTA PLANA

### SLOTTED SET SCREWS WITH FLAT POINT

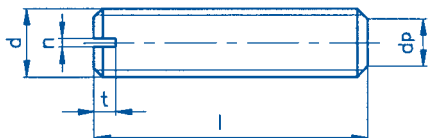

t min.	0,56	0,64	0,72	0,8	1,12	1,28	1,6	2	2,4
n	0,25	0,25	0,4	0,4	0,6	0,8	1	1,2	1,6
d <sub>p</sub>	0,8	1	1,5	2	2,5	3,5	4	5,5	7

d	M-1,6	M-2	M-2,5	M-3	M-4	M-5	M-6	M-8	M-10
L 2	197	172							
3	199	100	89,73						
4	202	104	86,21	66,85	51,02				
5	206	114	77,41	58,06	42,22	54,54			
6	209	118	77,41	58,06	43,98	49,26	61,58		
8	216	120	82,69	61,58	47,50	52,78	54,54	84,45	
10	230	125	87,97	68,61	51,02	58,06	59,82	84,45	160
12		128	91,49	72,13	54,54	61,58	65,10	91,49	160
16		134	96,76	79,17	61,58	68,61	73,89	106	160
20				84,45	66,85	75,65	84,45	121	183
25					72,13	87,97	96,76	143	206
30					84,45	98,52	111	164	250
35					158	172	194	222	310
40					172	183	206	241	333
45					179	195	215	264	355
50					188	206	229	297	401
60							259	357	515

Precios en € por 100 unidades. Medidas indicadas en m/m

## ESPARRAGOS RANURADOS PUNTA CONICA SLOTTED SET SCREWS WITH CONE POINT

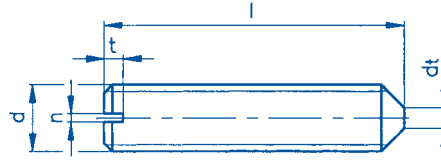

t min.	0,56	0,64	0,72	0,8	1,12	1,28	1,6	2	2,4
n	0,25	0,25	0,4	0,4	0,6	0,8	1	1,2	1,6
d <sub>t</sub>	0,16	0,2	0,25	0,3	0,4	0,5	1,5	2	2,5

d	M-1,6	M-2	M-2,5	M-3	M-4	M-5	M-6	M-8	M-10
L 2	157								
3	160	91,49	73,89						
4	164	93,24	75,65	43,98	42,22				
5	167	95,00	77,41	45,74	42,22	51,02			
6	174	102	77,41	49,26	43,98	49,26	59,82		
8	188	106	82,69	51,02	47,50	52,78	54,54	84,45	
10	227	113	87,97	54,54	51,02	58,06	59,82	84,45	127
12		120	91,49	58,06	54,54	61,58	65,10	91,49	127
16		134	96,76	61,58	61,58	68,61	73,89	106	127
20				72,13	66,85	75,65	84,45	121	264
25					75,65	87,97	96,76	143	281
30					84,45	98,52	111	164	315
35					158	172	169	222	361
40					172	183	206	241	378
45					179	195	215	264	396
50					188	206	229	297	431
60							259	357	519

Precios en € por 100 unidades. Medidas indicadas en m/m

### TUERCA CUADRADA SQUARE NUTS

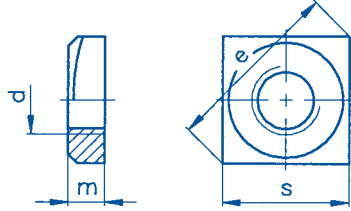

#### DIN 557

d	s	e	m	PRECIO
M-5	8	11,3	4	84,45
M-6	10	14,1	5	107
M-8	13	18,4	6,5	192
M-10	17	24	8	438
M-12	19	26,9	10	681

### TUERCA CUADRADA REBAJADA SQUARE THIN NUTS

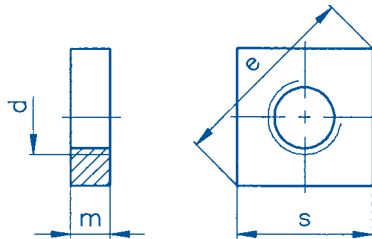

#### DIN 562

d	s	e	m	PRECIO
M-2	4	5	1,2	171
M-2,5	5	6,3	1,6	171
M-3	5,5	7	1,8	54,54
M-4	7	8,9	2,2	66,85
M-5	8	10,2	2,7	77,41
M-6	10	12,7	3,2	98,52
M-8	13	16,5	4	165
M-10	17	21,8	5	340

Precios en € por 100 unidades. Medidas indicadas en m/m



## TIRAFONDO CABEZA EXAGONAL HEXAGON HEAD WOOD SCREWS

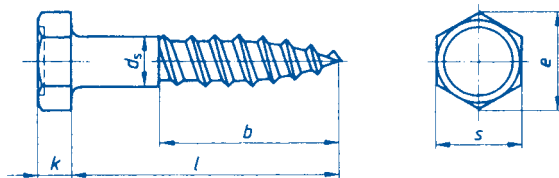

b	b ≥ 0,6 L							
k	2,8	3,5	4	5	5,5	7	8	10
e	7,5	8,63	10,89	13,07	14,2	18,72	20,88	26,17
s	7	8	10	12	13	17	19	24

d <sub>s</sub>	4	5	6	7	8	10	12	16
L 20	137	95	64,40					
25	95	55,24	57,53					
30	132	45,39	46,45	125	101			
35	143	50,49	51,90	127	116			
40	159	50,49	51,90	128	76,88	223		
45	194	59,11	60,35	165	85,08	280		
50	229	59,11	60,35	176	85,08	149	676	6.198
60		83,00	70,20	186	104	168	744	7.090
70		102	90,08	202	125	190	811	7.319
80			107	220	145	227	880	7.570
90			143	257	173	287	1.029	7.822
100			165	285	188	317	1.061	8.005
110			209	350	463	540	1.251	8.119
120			222	412	533	596	1.376	8.234
130					609	860	1.787	8.348
140					623	1.094	2.224	8.462
150					644	1.312	2.774	8.577
160					725	1.465	3.124	8.691
180						1.680	3.412	14.039
200					945	1.970	4.097	18.526

Precios en € por 100 unidades. Medidas indicadas en m/m



## TORNILLO DE CANGAMO

### LIFTING EYE BOLTS

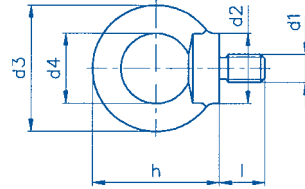

$d_1$	L	$d_2$	$d_3$	$d_4$	h	PRECIO
M-8	13	20	36	20	36	2.650
M-10	17	25	45	25	45	4.025
M-12	20,5	30	54	30	53	6.700
M-16	27	35	63	35	62	9.826
M-20	30	40	72	40	71	15.644
M-24	36	50	90	50	90	20.996
M-27	45	65	108	60	109	25.088
M-30	45	65	108	60	109	26.531
M-36	54	75	126	70	128	36.594

Precios en € por 100 unidades. Medidas indicadas en m/m

## TUERCA DE CANCAMO

### LIFTING EYE NUTS

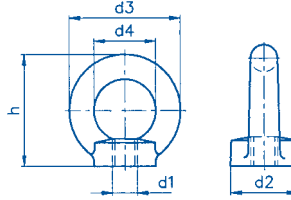

$d_1$	$d_2$	$d_3$	$d_4$	h	PRECIO
M-8	20	36	20	36	2.745
M-10	25	45	25	45	4.002
M-12	30	54	30	53	6.221
M-16	35	63	35	62	9.492
M-20	40	72	40	71	16.239
M-24	50	90	50	90	21.956
M-27	65	108	60	109	27.915
M-30	65	108	60	109	27.915
M-36	75	126	70	128	45.285

Precios en € por 100 unidades. Medidas indicadas en m/m

## TORNILLO CON CUELLO CUADRADO MUSHROOM HEAD SQUARE NECK BOLTS

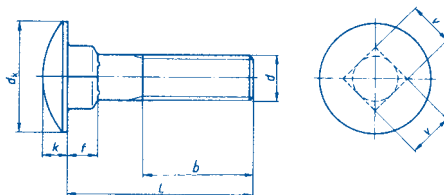

V min.	4,52	5,52	7,42	9,42	11,3	15,3
F max.	4,1	4,6	5,6	6,6	8,75	12,9
K max.	3,3	3,88	4,88	5,38	6,95	8,95
dk max	13,55	16,55	20,65	24,65	30,65	38,80
b L ≤ 125	16	18	22	26	30	38
b 125 < L ≤ 200	22	24	28	32	36	44

d	M-5	M-6	M-8	M-10	M-12	M-16
L 16	34,48	36,95	55,24	259		
20	38,18	39,59	58,76	211		
25	40,64	43,10	64,57	148		
30	47,85	47,50	70,55	162	354	2.516
35	59,29	52,78	85,50	172	369	2.630
40	66,50	57,18	88,85	181	399	2.697
45	98,52	68,09	98,70	202	426	2.827
50	116	77	105	220	498	2.956
60	130	90	124	246	596	3.216
70	160	118	140	299	642	3.480
80	192	139	162	350	739	3.740
90		188	257	454	920	4.011
100		225	292	523	1.033	4.282
110		324	515	943	1.371	4.555
120		373	635	1.249	1.700	4.833
130		505	954	1.499	2.041	5.123
140		589	1.052	1.798	2.449	5.413
150			1.209	2.159	2.936	5.702

Precios en € por 100 unidades. Medidas indicadas en m/m

## REMACHES CABEZA REDONDA ROUND HEAD RIVETS

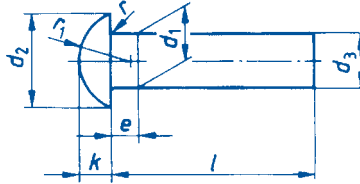

<b>d<sub>2</sub></b>	3,5	5,2	7	8,8	10,5	14
<b>d<sub>3</sub> min.</b>	1,87	2,87	3,87	4,82	5,82	7,76
<b>e max.</b>	1	1,5	2	2,5	3	4
<b>k</b>	1,2	1,8	2,4	3	3,6	4,8

<b>d<sub>1</sub></b>	<b>2</b>	<b>3</b>	<b>4</b>	<b>5</b>	<b>6</b>	<b>8</b>
<b>L 6</b>	29,91	35,19	56,30	89,73	135	287
<b>8</b>	31,67	36,95	59,82	91,49	137	297
<b>10</b>	35,19	40,46	66,85	100	146	320
<b>12</b>	36,95	43,98	75,65	111	164	366
<b>14</b>	36,95	49,26	86,21	128	186	412
<b>16</b>	38,71	54,54	89,73	139	206	424
<b>18</b>	40,46	56,30	91,49	144	213	440
<b>20</b>	42,22	58,06	98,52	157	229	503
<b>25</b>	43,98	61,58	111	181	252	561
<b>28</b>			121	188	271	603
<b>30</b>			130	194	278	618
<b>35</b>			151	197	313	676
<b>40</b>				227	355	690
<b>45</b>				252	389	762
<b>50</b>					461	888

Precios en € por 100 unidades. Medidas indicadas en m/m



## REMACHE CABEZA AVELLANADA COUNTERSUNK HEAD RIVETS

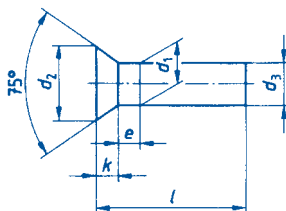

<b>d<sub>2</sub></b>	3,5	5,2	7	8,8	10,5	14
<b>d<sub>3</sub> min.</b>	1,87	2,87	3,87	4,82	5,82	7,76
<b>e max.</b>	1	1,5	2	2,5	3	4
<b>k</b>	1	1,4	2	2,5	3	4

<b>d<sub>1</sub></b>	<b>2</b>	<b>3</b>	<b>4</b>	<b>5</b>	<b>6</b>	<b>8</b>
<b>L 6</b>	29,91	28,15	56,30	89,73	135	287
<b>8</b>	33,43	36,95	59,82	91,49	137	297
<b>10</b>	35,19	40,46	66,85	100	146	320
<b>12</b>	36,95	43,98	75,65	111	162	366
<b>14</b>	38,71	49,26	86,21	128	186	412
<b>16</b>	38,71	54,54	87,97	141	206	424
<b>18</b>	40,46	54,54	91,49	144	213	440
<b>20</b>	42,22	58,06	98,52	157	229	503
<b>25</b>	43,98	66,85	111	181	252	561
<b>28</b>			121	188	271	603
<b>30</b>			130	192	278	618
<b>35</b>			151	197	313	676
<b>40</b>				227	355	690
<b>45</b>				252	389	762
<b>50</b>					461	888

Precios en € por 100 unidades. Medidas indicadas en m/m

## ANILLO DE RETENCION FORMA A ADJUSTING RINGS

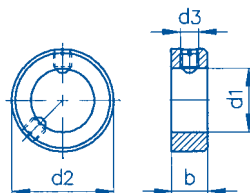

d <sub>1</sub>	b	d <sub>2</sub>	d <sub>3</sub>	Espárrago DIN-914 ó DIN-553	PRECIO
5	6	10	M3	M3x4	419
6	8	12	M4	M4x5	456
8	8	16	M4	M4x6	551
9	10	18	M5	M5x8	662
10	10	20	M5	M5x8	684
11	10	20	M5	M5x8	684
12	12	22	M6	M6x8	806
13	12	22	M6	M6x8	806
14	12	25	M6	M6x8	1.015
15	12	25	M6	M6x8	1.052
16	12	28	M6	M6x8	1.189
18	14	32	M6	M6x8	1.622
20	14	32	M6	M6x8	1.622
22	14	36	M6	M6x10	2.196
24	16	40	M8	M8x12	2.285
25	16	40	M8	M8x10	2.285
26	16	40	M8	M8x10	2.512
28	16	45	M8	M8x10	2.972
30	16	45	M8	M8x10	2.972
32	16	50	M8	M8x12	4.231
34	16	50	M8	M8x12	4.689
35	16	56	M8	M8x12	4.801
36	16	56	M8	M8x12	4.801
38	16	56	M8	M8x12	5.888
40	18	63	M10	M10x16	6.851
45	18	70	M10	M10x16	8.851
50	18	80	M10	M10x16	11.413

Precios en € por 100 unidades. Medidas indicadas en m/m



## TAPON ROSCADO CON EXAGONO INTERIOR ROSCA CONICA HEXAGON SOCKET PIPE PLUGS, CONICAL THREAD

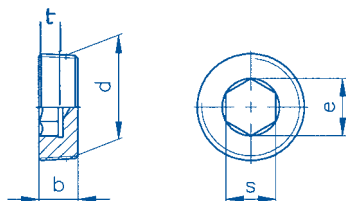

d	b	s	e	t min	PRECIO
M 8x1	8	4	4,6	4	938
M 10x1	8	5	5,7	4	961
M 12x1,5	10	6	6,9	5	1.110
M 14x1,5	10	7	8	5	1.258
M 16x1,5	10	8	9,2	5	1.327
M 18x1,5	10	8	9,2	5	1.464
M 20x1,5	10	10	11,4	5	1.578
M 22x1,5	10	10	11,4	5	1.738
M 24x1,5	12	12	13,7	6	2.630
M 26x1,5	12	12	13,7	6	5.489
M 27x2	12	12	13,7	6	5.718
M 30x1,5	12	17	19,4	6	6.267
M 30x2	12	17	19,4	6	6.610

R 1/8"	8	5	5,7	4	755
R 1/4"	10	7	8	5	961
R 3/8"	10	8	9,2	5	1.121
R 1/2"	10	10	11,4	5	1.636
R 3/4"	12	12	13,7	6	3.065
R 1"	12	17	19,4	6	6.678
R 1 1/4"	18	22	25,2	11,5	16.467
R 1 1/2"	20	24	27,4	11,5	20.127
R 2"	22	32	35,6	17	20.699

Precios en € por 100 unidades. Medidas indicadas en m/m



## TAPON ROSCADO CON EXAGONO INTERIOR ROSCA PASO FINO HEXAGON SOCKET SCREW PLUGS, CYLINDRICAL THREAD

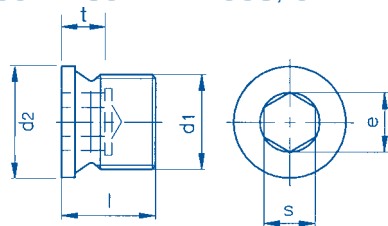

$d_1$	$d_2$	s	e	L	t min.	PRECIO
M 10x1	14	5	5,7	11	5	996
M 12x1,5	17	6	6,9	15	7	1.235
M 14x1,5	19	6	6,9	15	7	1.555
M 16x1,5	21	8	9,2	15	7,5	1.715
M 18x1,5	23	8	9,2	16	7,5	1.784
M 20x1,5	25	10	11,4	18	7,5	2.219
M 22x1,5	27	10	11,4	18	7,5	3.431
M 24x1,5	29	12	13,7	18	7,5	4.117
M 26x1,5	31	12	13,7	20	9	5.603
M 27x2	32	12	13,7	20	9	6.084
M 30x1,5	36	17	19,4	20	9	6.518
M 30x2	36	17	19,4	20	9	6.747

G 1/8"	14	5	5,7	11	5	904
G 1/4"	18	6	6,9	15	7	973
G 3/8"	22	8	9,2	15	7,5	1.487
G 1/2"	26	10	11,4	18	7,5	2.013
G 3/4"	32	12	13,7	20	9	3.042
G 1"	39	17	19,4	21	9	5.306
G 1 1/4"	49	22	25,2	21	10,5	19.669
G 1 1/2"	55	24	27,4	21	10,5	25.616
G 2"	68	32	36,6	25	14	40.025

Precios en € por 100 unidades. Medidas indicadas en m/m



## TAPON ROSCADO CABEZA EXAGONAL ROSCA PASO FINO HEXAGON SOCKET SCREW PLUGS WITH SHOULDER, CYLINDRICAL THREAD

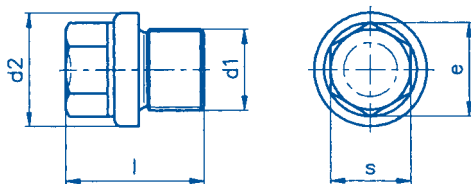

d <sub>1</sub>	d <sub>2</sub>	s	e	L	PRECIO
M 10x1	14	10	10,89	17	132
M 12x1,5	17	13	14,2	21	1.363
M 14x1,5	19	13	14,2	21	1.758
M 16x1,5	21	17	18,72	21	2.460
M 18x1,5	23	17	18,72	24	4.094
M 20x1,5	25	19	20,88	26	5.280
M 22x1,5	27	19	20,88	26	7.319
M 24x1,5	29	22	23,91	27	8.234
M 26x1,5	31	24	26,17	30	9.377
M 27x2	32	24	26,17	30	10.292
M 30x1,5	36	24	26,17	30	11.321
M 30x2	36	24	26,17	30	11.321

G 1/8"	14	10	10,89	17	1.258
G 1/4"	18	13	14,2	21	1.363
G 3/8"	22	17	18,72	21	1.758
G 1/2"	26	19	20,88	26	2.074
G 5/8"	28	19	21,9	26	2.679
G 3/4"	32	24	26,17	30	3.019
G 1"	39	27	29,56	32	6.404
G 1 1/4"	49	30	32,95	33	17.840
G 1 1/2"	55	30	32,95	33	21.499
G 2"	68	36	39,55	40	37.509

Precios en € por 100 unidades. Medidas indicadas en m/m

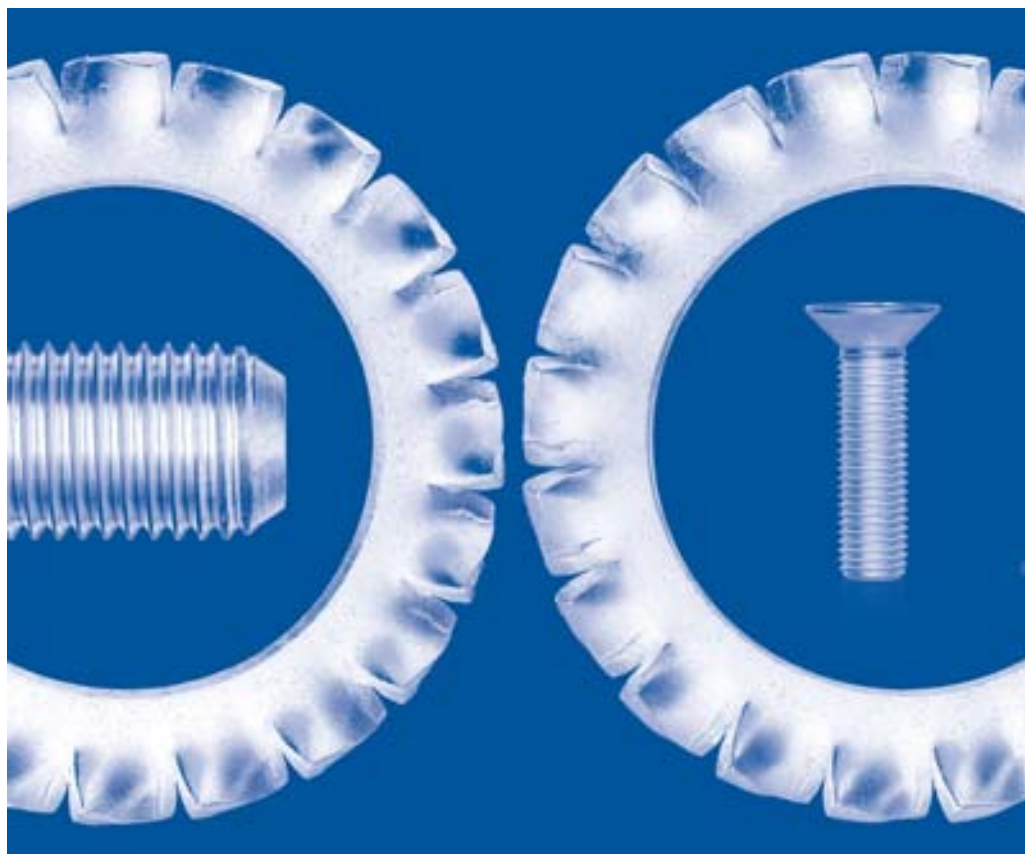

El futuro en tornillería se llama INOXIDABLE y el proveedor HISPANOX.

## TORNILLO CILINDRICO CON EXAGONO INTERIOR HEXAGON SOCKET HEAD CAP SCREWS

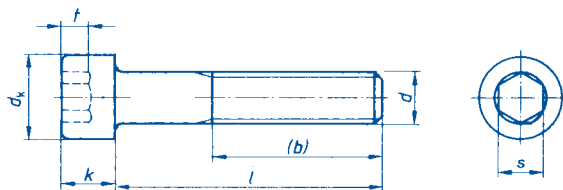

<b>b*</b>	15	16	17	18	20	22	24	28	32
<b>t min.</b>	0,7	1	1,1	1,3	2	2,5	3	4	5
<b>s</b>	1,5	1,5	2	2,5	3	4	5	6	8
<b>k max.</b>	1,6	2	2,5	3	4	5	6	8	10
<b>dk</b>	3	3,8	4,5	5,5	7	8,5	10	13	16

<b>d</b>	<b>M-1,6</b>	<b>M-2</b>	<b>M-2,5</b>	<b>M-3</b>	<b>M-4</b>	<b>M-5</b>	<b>M-6</b>	<b>M-8</b>	<b>M-10</b>
<b>L 5</b>	486	52,78	52,78	31,67	36,95				
<b>6</b>	519	43,98	43,98	14,43	21,82	27,27	57,35		
<b>8</b>	559	54,54	54,54	13,37	14,34	20,58	24,89		
<b>10</b>	586	59,82	59,82	13,55	13,72	14,95	20,76	39,59	
<b>12</b>		63,34	63,34	13,81	14,04	14,95	18,65	39,59	112
<b>14</b>		107	107	21,64	21,99	20,23	21,99	49,79	
<b>16</b>		68,61	68,61	14,16	14,29	15,66	17,77	36,86	103
<b>18</b>		130	130	25,86	24,45	22,17	24,98	57,53	
<b>20</b>		79,17	79,17	15,13	15,13	17,07	20,58	38,35	67,03
<b>22</b>				32,55	24,63	24,28	27,09	60,52	
<b>25</b>				21,64	16,36	20,23	23,40	41,17	70,73
<b>30</b>				25,69	19,18	23,40	26,57	46,36	76,09
<b>35</b>				34,83	22,08	27,09	30,26	51,90	84,62
<b>40</b>				46,80	24,38	29,82	33,60	57,35	93,07
<b>45</b>				93,24	34,83	35,89	38,00	63,16	103
<b>50</b>				93,24	38,71	37,47	40,29	68,44	110
<b>55</b>					104	93,24	59,82	79,35	123
<b>60</b>					82,69	54,89	48,91	79,35	127
<b>65</b>							79,17	105	140
<b>70</b>					322	102	64,92	105	142
<b>75</b>							118	204	236
<b>80</b>						134	77,59	145	160
<b>90</b>						218	107	178	191
<b>100</b>						294	134	195	222
<b>110</b>							253	338	408
<b>120</b>							315	401	459
<b>130</b>							398	461	510
<b>140</b>							676	767	852
<b>150</b>							767	857	943

\*Longitud constante de la rosca (siempre que L sea superior a b)

Precios en € por 100 unidades. Medidas indicadas en m/m

## TORNILLO CILINDRICO CON EXAGONO INTERIOR HEXAGON SOCKET HEAD CAP SCREWS

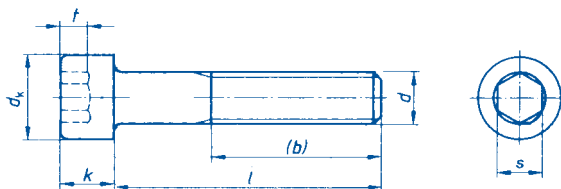

<b>h*</b>	36	40	44	48	52	56	60	66	72
<b>t min.</b>	6	7	8	9	10	11	12	13,5	15,5
<b>s</b>	10	12	14	14	17	17	19	19	22
<b>k max.</b>	12	14	16	18	20	22	24	27	30
<b>dk</b>	18	21	24	27	30	33	36	40	45

d	M-12	M-14	M-16	M-18	M-20	M-22	M-24	M-27	M-30
<b>L 16</b>	144								
<b>20</b>	92,37	545	545						
<b>25</b>	98,35	500	500						
<b>30</b>	104	322	322		1.645				
<b>35</b>	114	350	350	2.660	1.645				
<b>40</b>	126	378	378	2.065	1.147		8.651		
<b>45</b>	137	405	405	2.196	1.219		8.651		
<b>50</b>	149	440	440	2.350	1.305	9.894	7.319	10.873	12.175
<b>55</b>	170	498	498	2.616	1.453	10.046	7.713	11.061	12.389
<b>60</b>	172	505	505	2.616	1.453	10.275	5.143	11.295	12.650
<b>65</b>	199	563	563	2.894	1.608	10.486	5.241	11.532	12.917
<b>70</b>	204	572	572	2.894	1.608	10.486	5.241	11.532	12.917
<b>75</b>	347	647	647	3.170	1.761	11.295	5.649	12.424	13.916
<b>80</b>	252	654	654	3.170	1.761	11.295	5.649	12.424	13.916
<b>90</b>	310	755	755	3.424	1.902	12.685	6.335	13.953	15.628
<b>100</b>	354	804	804	3.693	2.051	13.582	6.793	14.937	16.731
<b>110</b>	535	1.027	1.027	4.152	2.306	16.327	8.165	17.963	20.118
<b>120</b>	596	1.195	1.195	5.026	2.801	17.840	8.920	19.625	21.891
<b>130</b>	669	1.383	1.383	5.732	3.184	19.212	9.606	21.133	23.672
<b>140</b>	950	2.263	2.263	6.617	3.774	20.584	10.292	22.643	25.370
<b>150</b>	1.042	2.833	2.833	7.773	4.719	21.956	10.978	24.156	27.055
<b>160</b>	1.246		4.141		6.133		12.294		
<b>170</b>	1.559		5.326		7.973		13.770		
<b>180</b>	1.756		5.735		10.366		15.424		
<b>200</b>	2.146		6.809		13.476		17.570		

\*Longitud constante de la rosca (siempre que L sea superior a b)

Precios en € por 100 unidades. Medidas indicadas en m/m



## ESPARRAGO ROSCADO CON EXAGONO INTERIOR PUNTA PLANA

### HEXAGON SOCKET SET SCREWS WITH FLAT POINT

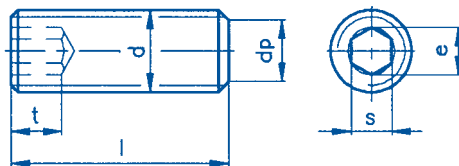

<b>d<sub>p</sub> max.</b>	1	1,5	2	2,5	3,5	4	5,5	7	8,5	10	12	15
<b>t min.</b>	0,8	1,2	1,2	1,5	2	2	3	4	4,8	5,5	6,4	8
<b>e</b>	1	1,42	1,73	2,3	2,87	3,44	4,58	5,72	6,86	6,86	9,15	11,43
<b>s</b>	0,9	1,3	1,5	2	2,5	3	4	5	6	6	8	10

<b>d</b>	<b>2</b>	<b>2,5</b>	<b>3</b>	<b>4</b>	<b>5</b>	<b>6</b>	<b>8</b>	<b>10</b>	<b>12</b>	<b>14</b>	<b>16</b>	<b>20</b>
<b>L 2</b>	33,4											
<b>3</b>	25,2	18,0	7,1	8,0								
<b>4</b>	25,4	18,5	6,0	6,5	7,7							
<b>5</b>	26,7	18,8	6,1	5,9	6,9	12,8						
<b>6</b>	27,8	19,8	6,3	6,1	6,3	7,9	15,7					
<b>8</b>	32,2	22,9	6,5	6,3	6,7	7,6	11,7	26,5				
<b>10</b>	34,6	24,6	6,9	6,7	7,3	8,3	12,8	22,2	59,5			
<b>12</b>	37,0	27,0	7,9	7,5	8,1	9,1	13,7	21,8	43,9			
<b>16</b>			12,3	10,1	10,7	11,3	16,6	26,9	51,3	174	252	
<b>20</b>			18,5	15,1	13,6	14,2	19,9	30,7	58,1	205	269	1.345
<b>25</b>			25,2	20,5	18,3	20,1	24,5	36,8	66,8	215	286	1.435
<b>30</b>			37,8	28,7	24,1	25,2	30,6	42,1	77,5	227	306	1.550
<b>35</b>				36,7	30,2	32,7	37,7	50,9	90,0	241	347	1.735
<b>40</b>				42,8	36,3	38,9	46,9	63,3	98,2	252	371	1.870
<b>45</b>					43,7	46	56,7	76,5	112	269	397	1.993
<b>50</b>					54,7	59	64,8	87,4	122	301	420	2.101
<b>60</b>						76,4	69,7	137	184	385	474	2.370
<b>70</b>						105	88,0	163	221	495	570	2.850
<b>80</b>							125	230	310	622	684	3.420
<b>90</b>							187	352	475	747	821	4.105
<b>100</b>							239	438	591	895	985	4.962

Precios en € por 100 unidades. Medidas indicadas en m/m

## ESPARRAGO ROSCADO CON EXAGONO INTERIOR PUNTA CONICA HEXAGON SOCKET SET SCREWS WITH CONE POINT

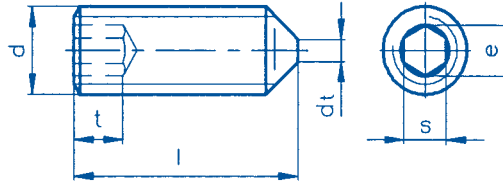

<b>d, max.</b>	-	-	0,4	0,5	1	1,5	2	2,5	3	4	5
<b>t min.</b>	0,8	1,2	1,2	1,5	2	2	3	4	4,8	6,4	8
<b>e</b>	1	1,42	1,73	2,3	2,87	3,44	4,58	5,72	6,86	9,15	11,43
<b>s</b>	0,9	1,3	1,5	2	2,5	3	4	5	6	8	10

<b>d</b>	<b>2</b>	<b>2,5</b>	<b>3</b>	<b>4</b>	<b>5</b>	<b>6</b>	<b>8</b>	<b>10</b>	<b>12</b>	<b>16</b>	<b>20</b>
<b>L 2</b>	37,5										
<b>3</b>	28,3	21,3	8,8								
<b>4</b>	28,3	21,3	7,9	7,7	11,3						
<b>5</b>	29,0	21,8	7,5	6,8	8,3	15,7					
<b>6</b>	30,3	22,7	7,8	7,1	7,9	9,8					
<b>8</b>	34,9	26,2	8,1	7,5	8,2	9,2	18,9				
<b>10</b>	37,0	27,8	8,5	8,1	8,6	9,6	15,7	36,5			
<b>12</b>	74,7	31,0	9,6	9,1	9,7	10,6	17,5	27,9	74,6		
<b>16</b>			14,1	11,9	12,6	12,4	21,4	32,4	64,5	446	
<b>20</b>			20,2	18,0	15,7	16,6	26,6	37,9	73,1	457	1.443
<b>25</b>				24,8	21,8	22,9	31,2	48,6	87,1	514	1.495
<b>30</b>				29,7	26,2	27,3	35,9	59,7	103	572	1.586
<b>35</b>				35,9	32,7	34,2	44,2	69,2	124	624	1.625
<b>40</b>				40,1	38,6	41,4	51,4	77,4	135	663	1.664
<b>45</b>					50,2	44,7	62,5	100	155	728	1.690
<b>50</b>					65,3	49,3	71,7	110	166	1.040	2.210
<b>60</b>						59,2	102	125	235	1.131	2.340
<b>70</b>							123	151	289	1.209	2.470
<b>80</b>									361	1.467	3.250

Precios en € por 100 unidades. Medidas indicadas en m/m

## ESPARRAGO ROSCADO CON EXAGONO INTERIOR PUNTA DE PIVOTE HEXAGON SOCKET SET SCREWS WITH DOG POINT

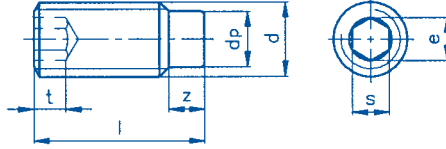

<b>d<sub>p</sub> max.</b>	1	1,5	2	2,5	3,5	4	5,5	7	8,5	12	15
<b>t min.</b>	0,8	1,2	1,2	1,5	2	2	3	4	4,8	6,4	8
<b>e</b>	1,00	1,42	1,73	2,3	2,87	3,44	4,58	5,72	6,86	9,15	11,43
<b>s</b>	0,9	1,3	1,5	2	2,5	3	4	5	6	8	10

d	2	2,5	3	4	5	6	8	10	12	16	20
<b>L 3</b>	67,0	55,0	24,8								
<b>4</b>	71,0	60,0	21,0								
<b>5</b>	76,0	66,0	21,4	20,7	22,8						
<b>6</b>	82,0	71,0	22,1	21,4	22,1	27,7					
<b>8</b>	89,0	78,0	22,8	22,1	23,5	26,6	41,1				
<b>10</b>	97,0	86,0	24,1	23,5	25,6	29,1	44,7	77,7			
<b>12</b>	106	95,0	27,5	26,3	28,2	31,9	48,0	76,3	132		
<b>16</b>			43,2	35,3	35,3	38,2	58,1	94,2	154	756	
<b>20</b>			64,8	52,9	44,5	46,2	69,7	107	175	858	1.443
<b>25</b>				71,8	64,1	69,2	82,3	129	201	917	1.495
<b>30</b>				84,8	73,9	81,9	97,0	148	233	1.041	1.586
<b>35</b>					105	102	110	179	270	1.191	1.625
<b>40</b>					127	114	121	222	295	1.260	1.684
<b>50</b>					191	156	227	306	366	1.422	1.790
<b>60</b>						267	284	479	552	1.710	2.210
<b>70</b>							308	571	663	2.052	2.420
<b>80</b>								792	930	2.463	2.770

Precios en € por 100 unidades. Medidas indicadas en m/m



## ESPARRAGO ROSCADO CON EXAGONO INTERIOR PUNTA CON CHAFLAN Y CONO INTERNO HEXAGON SOCKET SET SCREWS WITH CUP POINT

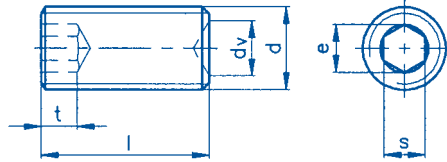

<b>d<sub>v</sub> max.</b>	1	1,2	1,4	2	2,5	3	5	6	8	9	10	14
<b>t min.</b>	0,8	1,2	1,2	1,5	2	2	3	4	4,8	5,5	6,4	8
<b>e</b>	1,00	1,42	1,73	2,3	2,87	3,44	4,58	5,72	6,86	6,86	9,15	11,43
<b>s</b>	0,9	1,3	1,5	2	2,5	3	4	5	6	6	8	10

<b>d</b>	<b>2</b>	<b>2,5</b>	<b>3</b>	<b>4</b>	<b>5</b>	<b>6</b>	<b>8</b>	<b>10</b>	<b>12</b>	<b>14</b>	<b>16</b>	<b>20</b>
<b>L 2</b>	36,1											
<b>3</b>	27,2	19,4	7,7	8,6								
<b>4</b>	27,4	20,0	6,5	7,0	8,3							
<b>5</b>	28,8	20,3	6,6	6,4	7,5	13,8						
<b>6</b>	30,0	21,4	6,8	6,6	6,8	8,5	17,0					
<b>8</b>	34,8	24,7	7,0	6,8	7,2	8,2	12,6	28,6				
<b>10</b>	37,4	26,6	7,5	7,2	7,9	9,0	13,8	24,0	64,3			
<b>12</b>	40,0	29,2	8,5	8,1	8,7	9,8	14,8	23,5	47,4			
<b>16</b>			13,3	10,9	11,6	12,2	17,9	29,1	55,4	188	272	
<b>20</b>			20,0	16,3	14,7	15,3	21,5	33,2	62,7	221	291	1.453
<b>25</b>			27,2	22,1	19,8	21,7	26,5	29,7	72,1	232	309	1.550
<b>30</b>			40,8	31,0	26,0	27,2	33,0	45,5	83,7	245	331	1.674
<b>35</b>				39,6	32,6	35,3	40,7	55,0	97,2	260	375	1.874
<b>40</b>				46,2	39,2	42,0	50,7	68,4	106	272	401	2.020
<b>45</b>					47,2	41,3	61,2	82,6	121	291	429	2.152
<b>50</b>					59,1	48,1	70,0	94,4	132	325	454	2.269
<b>60</b>						82,5	75,3	148	199	416	512	2.560
<b>70</b>						113	95,0	176	239	535	616	3.078
<b>80</b>							132	248	335	672	739	3.694
<b>90</b>							202	380	513	807	887	4.433
<b>100</b>							258	473	638	967	1.064	5.359

Precios en € por 100 unidades. Medidas indicadas en m/m



## TUERCAS DE SOMBRERETE EXAGONALES FORMA BAJA HEXAGON CAP NUTS

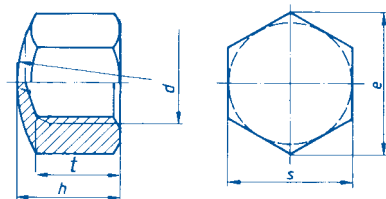

d	s	h	t min.	PRECIO
M-4	7	5,5	4,16	84,45
M-5	8	7	4,96	95,00
M-6	10	9	6,71	113
M-8	13	12	9,21	172
M-10	17	14	10,65	297
M-12	19	16	13,15	401
M-14	22	18	14,65	778
M-16	24	20	16,65	778
M-18	27	22	18,58	1.464
M-20	30	25	20,58	1.464
M-22	32	28	21,58	2.333
M-24	36	30	23,58	2.333
M-27	41	32	25,58	4.117
M-30	46	34	27,58	5.603

Precios en € por 100 unidades. Medidas indicadas en m/m

## TUERCAS PARA SOLDAR - CUADRADAS SQUARE WELD NUTS

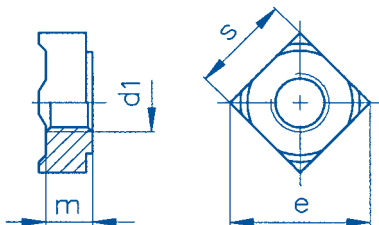

### DIN 928

d <sub>1</sub>	s	e	m	PRECIO
M-5	8	11	4,2	144
M-6	10	13	5	199
M-8	14	18	6,5	236

## TUERCAS PARA SOLDAR - EXAGONALES HEXAGON WELD NUTS

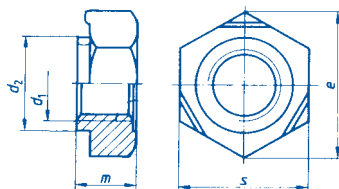

### DIN 929

d <sub>1</sub>	s	e	m	d <sub>2</sub>	PRECIO
M-3	7,5	8,15	3	4,5	61,58
M-4	9	9,83	3,5	6	77,41
M-5	10	10,95	4	7	111
M-6	11	12,02	5	8	153
M-8	14	15,38	6,5	10,5	181
M-10	17	18,74	8	12,5	297
M-12	19	20,91	10	14,8	508
M-16	24	26,51	13	18,8	904

Precios en € por 100 unidades. Medidas indicadas en m/m



## TORNILLO CABEZA EXAGONAL ROSCA PARCIAL HEXAGON HEAD BOLTS

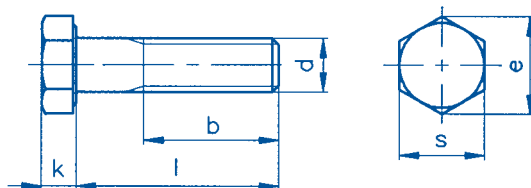

<b>k</b>	3,5	4	5,3	6,4	7,5	8,8	10	11,5
<b>e</b>	8,79	11,05	14,38	18,90	21,10	24,49	26,75	30,14
<b>s</b>	8	10	13	17	19	22	24	27
<b>b para L ≤ 125</b>	16	18	22	26	30	34	38	42
<b>b para 125 &lt; L &lt; 200</b>		24	28	32	36	40	44	48
<b>b para L &gt; 200</b>				45	49	53	57	61

<b>d</b>	<b>M-5</b>	<b>M-6</b>	<b>M-8</b>	<b>M-10</b>	<b>M-12</b>	<b>M-14</b>	<b>M-16</b>	<b>M-18</b>
<b>L 30</b>	29,52	32,64	62,32					
<b>35</b>	31,72	36,86	68,84	118				
<b>40</b>	34,41	40,85	75,05	121	162			
<b>45</b>	38,85	44,86	81,91	133	170			
<b>50</b>	43,49	48,42	85,36	140	179	366	366	
<b>55</b>	53,78	56,37	96,13	155	197	368	368	
<b>60</b>	58,06	59,94	97,29	164	208	394	378	987
<b>65</b>	104	71,68	108	169	218	420	420	1.024
<b>70</b>	79,17	75,44	114	170	234	429	429	1.049
<b>75</b>		91,66	135	193	267	466	466	1.138
<b>80</b>		91,66	138	199	274	487	487	1.151
<b>90</b>		112	162	232	306	579	579	1.254
<b>100</b>		134	186	262	334	630	630	1.376
<b>110</b>		162	206	331	375	702	702	1.466
<b>120</b>		199	227	375	433	771	734	1.645
<b>130</b>			297	450	549	823	778	1.858
<b>140</b>			389	477	603	883	883	2.124
<b>150</b>			466	486	663	987	987	2.303
<b>160</b>			559	603	830	1.158	1.158	2.651
<b>170</b>			672	737	1.036	1.553	1.553	3.154
<b>180</b>			735	853	1.295	1.657	1.657	3.503
<b>190</b>				1.096	1.724	2.092	2.092	3.920
<b>200</b>				1.212	2.023	2.421	2.421	4.384
<b>210</b>					2.268		2.713	
<b>220</b>					2.539		3.037	
<b>230</b>					2.845		3.403	
<b>240</b>					3.186		3.809	
<b>250</b>					3.570		4.266	

Precios en € por 100 unidades. Medidas indicadas en m/m

## TORNILLO CABEZA EXAGONAL ROSCA PARCIAL HEXAGON HEAD BOLTS

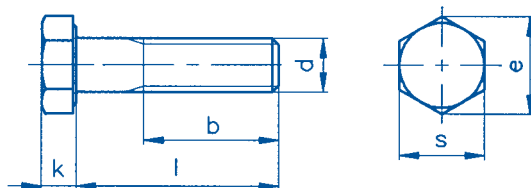

<b>k</b>	12,5	14	15	17	18,7	21	22,5
<b>e</b>	33,53	35,72	39,98	45,20	50,85	55,37	60,79
<b>s</b>	30	32	36	41	46	50	55
<b>b para L ≤ 125</b>	46	50	54	60	66	72	78
<b>b para 125 &lt; L &lt; 200</b>	52	56	60	66	72	78	84
<b>b para L &gt; 200</b>	65	69	73	79	85	91	97

<b>d</b>	<b>M-20</b>	<b>M-22</b>	<b>M-24</b>	<b>M-27</b>	<b>M-30</b>	<b>M-33</b>	<b>M-36</b>
<b>L 65</b>	853						
<b>70</b>	874	2.143	1.608				
<b>75</b>	948	2.291	1.724				
<b>80</b>	959	2.310	1.733	3.093	3.712		
<b>90</b>	1.045	2.512	1.884	3.255	3.904	5.764	
<b>100</b>	1.147	2.857	2.041	3.540	4.439	6.226	7.609
<b>110</b>	1.256	3.070	2.194	3.974	4.770	6.610	8.147
<b>120</b>	1.371	3.223	2.301	4.170	5.005	7.109	8.608
<b>130</b>	1.548	3.424	2.445	4.432	5.318	7.532	9.069
<b>140</b>	1.770	3.608	2.577	4.671	5.605	7.917	9.530
<b>150</b>	1.919	3.895	2.782	5.040	6.049	8.454	9.991
<b>160</b>	2.210	4.212	3.008	5.454	6.545	9.222	10.758
<b>170</b>	2.628	4.717	3.496	7.240	7.864	9.641	11.378
<b>180</b>	2.919	5.285	3.862	8.242	8.688	10.554	12.456
<b>190</b>	3.267	5.918	4.381	8.867	9.393	11.490	13.557
<b>200</b>	3.652	6.627	4.713	9.351	9.896	12.023	14.187
<b>210</b>	4.817		6.126	10.239	10.845	12.643	14.919
<b>220</b>	5.746		6.995	11.840	12.380	13.805	16.291
<b>230</b>	6.437		8.045	13.392	14.238	16.091	18.987
<b>240</b>	7.437		9.251	15.377	16.374	18.125	21.386
<b>250</b>	8.515		10.340	16.028	18.301	20.051	23.661
<b>260</b>	9.537		11.374	17.060	20.130	22.055	26.028
<b>270</b>	10.681		12.512	18.769	22.143	24.261	28.631
<b>280</b>	11.962		13.763	20.644	24.358	26.687	31.494
<b>290</b>	13.399		15.139	22.708	26.795	29.356	34.643
<b>300</b>	15.007		16.652	24.979	29.474	32.293	38.107

Precios en € por 100 unidades. Medidas indicadas en m/m



## TORNILLO CABEZA EXAGONAL HEXAGON HEAD SCREWS

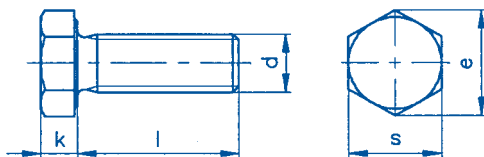

<b>k</b>	1,4	1,7	2	2,8	3,5	4	5,3	6,4	7,5	8,8
<b>e</b>	4,32	5,45	6,01	7,66	8,79	11,05	14,38	18,9	21,1	24,49
<b>s</b>	4	5	5,50	7	8	10	13	17	19	22

<b>d</b>	<b>M-2</b>	<b>M-2,5</b>	<b>M-3</b>	<b>M-4</b>	<b>M-5</b>	<b>M-6</b>	<b>M-8</b>	<b>M-10</b>	<b>M-12</b>	<b>M-14</b>
5	123	123	14,43							
6	123	123	11,96	15,31	21,99					
8	141	141	10,91	11,08	13,90	16,80				
10	158	158	11,35	11,79	12,70	15,43	34,48	126		
12	176	176	11,88	12,32	13,11	14,41	30,79	81,46		
14	211	211	15,66	16,19	18,82	20,41	39,76			
16	229	229	12,35	12,84	13,37	14,57	28,33	56,83	111	
18			17,24	17,51	20,94	20,94	43,10			
20	264	264	12,84	13,28	14,88	16,08	30,70	57,71	95,88	211
22				18,82	23,75	25,86	47,68	84,62		
25			15,13	15,66	16,89	18,47	34,66	60,52	91,84	204
30			18,30	17,77	19,44	21,46	38,53	66,33	95,36	185
35			26,92	22,52	21,46	24,28	42,40	72,31	103	194
40			27,97	23,61	23,93	26,83	46,80	76,36	110	202
45				34,66	26,74	29,38	51,46	85,33	121	218
50				41,87	29,03	31,84	57,53	90,96	128	230
55					45,21		63,34	104	140	250
60				83,74	45,21	43,10	65,62	104	145	262
65					102	47,15	74,95	114	158	281
70				121	102	48,73	78,64	118	163	292
75						78,29	116	171	232	362
80					157	57,35	95,53	144	204	322
90						65,45	105	159	223	405
100						69,85	115	179	243	442
110						138	167	278	354	535
120						189	208	315	396	586
130							265	413	475	735
140							346	524	572	917
150							492	646	684	1.147

Precios en € por 100 unidades. Medidas indicadas en m/m

## TORNILLO CABEZA EXAGONAL HEXAGON HEAD SCREWS

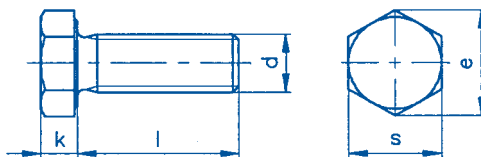

<b>k</b>	10	11,5	12,5	14	15	17	18,7	21	22,5
<b>e</b>	26,75	30,14	33,53	35,72	39,98	45,2	50,85	55,37	60,79
<b>s</b>	24	27	30	32	36	41	46	50	55

<b>d</b>	<b>M-16</b>	<b>M-18</b>	<b>M-20</b>	<b>M-22</b>	<b>M-24</b>	<b>M-27</b>	<b>M-30</b>	<b>M-33</b>	<b>M-36</b>
<b>L 20</b>	313								
<b>25</b>	225								
<b>30</b>	209	410	412						
<b>35</b>	202	424	385						
<b>40</b>	213	438	398	1.659	1.242				
<b>45</b>	232	463	420	1.717	1.242				
<b>50</b>	243	479	435	1.740	1.242	1.863	2.968		
<b>55</b>	262	523	475	1.858	1.312				
<b>60</b>	276	535	486	1.902	1.365	2.048	2.968		
<b>65</b>	296	584	530	1.970	1.429	2.143	3.107		
<b>70</b>	308	595	540	2.013	1.481	2.224	3.225	5.387	7.178
<b>75</b>	341	642	582	2.139	1.578	2.454			
<b>80</b>	341	651	591	2.139	1.636	2.454	3.559	5.832	7.343
<b>90</b>	403	707	642	2.317	1.821	2.730	3.959	6.244	7.720
<b>100</b>	436	764	693	2.463	1.995	2.993	4.340	6.656	8.302
<b>110</b>	501	915	830	2.884	2.192	3.288	4.768	7.410	9.161
<b>120</b>	537	994	904	3.012	2.460	3.689	5.348	7.857	9.606
<b>130</b>	574	1.145	1.042	3.480	2.780	4.170	6.047	8.234	10.121
<b>140</b>	640	1.212	1.103	4.344	3.227	4.840	7.018	8.681	10.670
<b>150</b>	698	1.290	1.172	5.162	3.549	5.322	7.718	9.161	11.161
<b>160</b>	1.045		1.780		3.904	5.876	8.603	10.005	11.948
<b>170</b>	1.291		2.106		4.295				
<b>180</b>	1.376		2.424		4.724				
<b>190</b>	1.858		2.789		5.197				
<b>200</b>	1.858		2.789		5.716				

Precios en € por 100 unidades. Medidas indicadas en m/m





HISPANOX, el inmenso universo de la tornillería inoxidable.



## TORNILLO EXAGONAL ROSCA UNC - WHITWORTH HEXAGON HEAD SCREWS - WHITWORTH

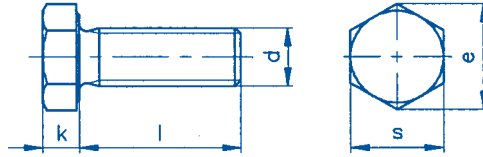

	UNC	UNC	UNC	UNC	UNC	UNC	UNC	UNC	W
<b>k</b>	4	5,2	6	7,9	9,9	11,9	14	16	7,9
<b>s</b>	11,1	12,7	14,3	19	23,8	28,6	33,3	38,1	20,8
<b>Paso h</b>	20	18	16	13	11	10	9	8	12

d	UNC								W
	1/4	5/16	3/8	1/2	5/8	3/4	7/8	1	1/2
<b>L 9,5</b>	75,65								
<b>13</b>	80,93								
<b>16</b>	84,45	289							
<b>19</b>	91,49	352	336	468					468
<b>25</b>	96,76	366	354	487					487
<b>32</b>	111	389	369	528	1.342	2.060			528
<b>38</b>	134	489	431	607	1.531	2.301			607
<b>45</b>	148	507	452	644	1.575	2.424			644
<b>50</b>	151	535	472	663	1.615	2.507	6.453	9.034	663
<b>56</b>	162	565	487	681	1.641	2.542	6.712	9.397	681
<b>63</b>	178	593	547	758	1.742	2.651	6.809	9.532	758
<b>75</b>		662	656	892	1.946	3.056	7.025	9.835	892
<b>81</b>		797	683	913	2.000	3.292	7.354	10.296	913
<b>88</b>		1.059	786	992	2.097	4.189	8.044	11.261	992
<b>100</b>		1.122	903	1.087	2.199	4.653	8.915	12.481	1.087

Precios en € por 100 unidades. Medidas indicadas en m/m

## TUERCA EXAGONAL HEXAGON NUTS

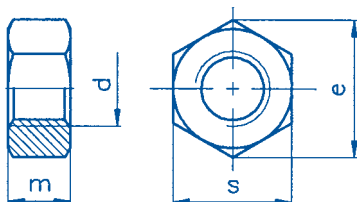

d	s	e	m	PRECIO
M-1,6	3,2	3,48	1,3	68,61
M-2	4	4,38	1,6	7,65
M-2,5	5	5,45	2	7,65
M-3	5,5	6,01	2,4	3,15
M-3,5	6	6,58	2,8	25,69
M-4	7	7,66	3,2	3,34
M-5	8	8,79	4	3,78
M-6	10	11,05	5	6,25
M-7	11	12,12	5,5	52,08
M-8	13	14,38	6,5	12,67
M-10	17	18,9	8	28,27
M-12	19	21,1	10	41,45
M-14	22	24,49	11	59,55
M-16	24	26,75	13	83,57
M-18	27	29,56	15	133
M-20	30	32,95	16	175
M-22	32	35,03	18	246
M-24	36	39,55	19	320
M-27	41	45,2	22	1.024
M-30	46	50,85	24	1.154
M-33	50	55,37	26	1.692
M-36	55	60,79	29	2.468
M-39	60	66,44	31	4.752
M-42	65	72,09	34	6.492
M-45	70	76,95	36	12.284
M-48	75	82,6	38	14.492
M-52	80	88,25	42	17.512

Precios en € por 100 unidades. Medidas indicadas en m/m

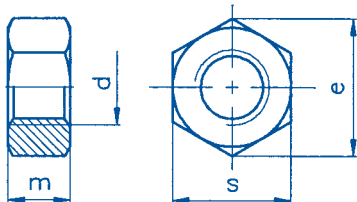
**TUERCA EXAGONAL ROSCA IZQUIERDA**  
HEXAGON NUTS LEFT HAND THREAD

$d$	$s$	$e$	$m$	PRECIO
M-5-I	8	8,79	4	120
M-6-I	10	11,05	5	153
M-8-I	13	14,38	6,5	238
M-10-I	17	18,9	8	320
M-12-I	19	21,1	10	399
M-14-I	22	24,49	11	642
M-16-I	24	26,75	13	751
M-18-I	27	29,56	15	1.622
M-20-I	30	32,95	16	1.819
M-22-I	32	35,03	18	2.257
M-24-I	36	39,55	19	2.616
M-27-I	41	45,2	22	4.277
M-30-I	46	50,85	24	5.718

Precios en € por 100 unidades. Medidas indicadas en m/m

## TUERCA EXAGONAL PASO FINO

### HEXAGON NUTS FINE PITCH

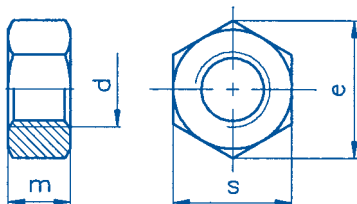

d	s	e	m	PRECIO
M 8 x 1	13	14,38	6,5	125
M 10 x 1	17	18,9	8	197
M 10 x 1,25	17	18,9	8	197
M 12 x 1,25	19	21,1	10	266
M 12 x 1,50	19	21,1	10	266
M 14 x 1,50	22	24,49	11	435
M 16 x 1,50	24	26,75	13	618
M 18 x 1,50	27	29,56	15	1.230
M 20 x 1,50	30	32,95	16	1.777
M 20 x 2	30	32,95	16	1.777
M 22 x 1,5	32	35,03	18	2.356
M 24 x 1,5	36	39,55	19	2.609
M 24 x 2	36	39,55	19	2.609
M 27 x 1,5	41	45,2	22	3.487
M 27 x 2	41	45,2	22	3.487
M 30 x 1,5	46	50,85	24	4.435
M 30 x 2	46	50,85	24	4.435
M 36 x 1,5	55	60,79	29	6.722
M 36 x 3	55	60,79	29	6.722

Precios en € por 100 unidades. Medidas indicadas en m/m

## TUERCA EXAGONAL ROSCA UNC HEXAGON NUTS - UNC

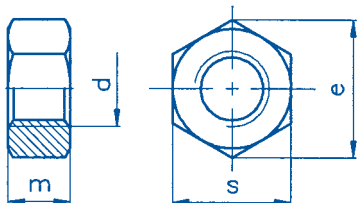

d	m	s	PRECIO
8.32	3,3	8,7	204
10.24	3,3	9,5	204
12.24	4,1	11,1	204
1/4	5,7	11,1	93,24
5/16	6,9	12,7	178
3/8	8,5	14,3	225
7/16	9,7	17,5	289
1/2	11,2	19,05	338
9/16	12,4	22,2	523
5/8	14	23,8	544
3/4	16,5	28,6	853
7/8	19,3	33,3	1233
1	22,2	38,1	1703
1 1/8	25,2	42,9	3.061
1 1/4	27,6	47,6	3.260
1 3/8	30,4	52,4	4.156
1 1/2	33,3	57,1	5.097

Precios en € por 100 unidades. Medidas indicadas en m/m

### TUERCA EXAGONAL ROSCA WHITWORTH

### HEXAGON NUTS WHITWORTH

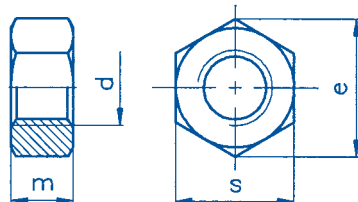

d	m	s	PRECIO
3/16	4,1	8,2	109
1/4	5,1	11,3	93,24
5/16	6,3	13,3	178
3/8	7,9	15,2	225
7/16	9,5	18,04	289
1/2	11,1	20,8	338
5/8	14,3	25,7	544
3/4	17,4	30,5	853
7/8	19,1	33,02	1.233
1	22,2	37,6	1.703
1 1/8	25,4	42,4	3.061
1 1/4	28,6	47,2	3.260
1 3/8	31,8	52,1	4.156
1 1/2	34,9	56,4	5.097

Precios en € por 100 unidades. Medidas indicadas en m/m

## TUERCA ALMENADA HEXAGON CASTLE NUTS, SLOTTED

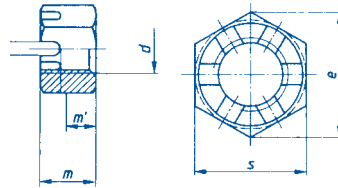

d	s	e	m	m' min.	PRECIO
M-5	8	8,79	6	3	336
M-6	10	11,05	7,5	3,8	355
M-8	13	14,38	9,5	4,9	449
M-10	17	18,9	12	6,1	749
M-12	19	21,1	15	7,7	1.119
M-14	22	24,49	16	8,2	1.735
M-16	24	26,75	19	9,8	1.814
M-18	27	29,56	21	11,2	2.982
M-20	30	32,95	22	11,9	3.313
M-24	36	39,55	27	14,2	5.521
M-27	41	45,2	30	16,6	9.034
M-30	46	50,85	33	18,2	9.993

Precios en € por 100 unidades. Medidas indicadas en m/m

## TUERCA EXAGONAL BAJA HEXAGON THIN NUTS

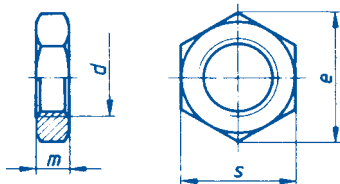

d	s	e	m	PRECIO
M-8	13	14,38	5	18,37
M-10	17	18,9	6	43,54
M-12	19	21,1	7	57,62
M-14	22	24,49	8	176
M-16	24	26,75	8	192
M-18	27	29,56	9	547
M-20	30	32,95	9	647
M-22	32	35,03	10	1.209
M-24	36	39,55	10	1.648
M-27	41	45,2	12	2.224
M-30	46	50,85	12	3.003
M-33	50	55,37	14	4.073
M-36	55	60,79	14	5.486
M-39	60	66,44	16	7.407
M-42	65	71,3	16	9.979

Precios en € por 100 unidades. Medidas indicadas en m/m



## ESPARRAGO ROSCADO EN CADA EXTREMO 1d STUDS, NUT END $\approx 1d$

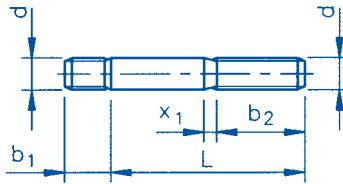

$b_1 \approx 1d$	5	6	8	10	12	14	16	20	22	24
$b_2 (1)$	14	18	22	26	30	34	38	46	50	54
$x_1$	2	2,5	3,2	3,8	4,3	5	5	6,3	6,3	7,5
$b_2 (2)$	20	24	28	32	36	40	44	52	56	60

d	M-5	M-6	M-8	M-10	M-12	M-14	M-16	M-20	M-22	M-24
L 16	245 *	245 *	304							
20	255 *	255 *	310 *	396 *	515					
25	264	264 *	333 *	424 *	519 *					
30	281	281	350	442 *	554 *	1.061 *	1.061			
35	290	290	364	479	584 *	1.117 *	1.117 *			
40	296	296	387	496	625	1.135 *	1.135 *	1.700 *		
45	304	304	401	530	656	1.156	1.156 *	1.707 *	2.387	
50	318	318	410	565	695	1.189	1.189	1.865 *	2.498 *	2.813
55	333	333	435	581	746	1.288	1.288	1.976 *	2.630 *	2.975
60	347	347	449	602	776	1.371	1.371	2.011	2.757 *	3.065 *
65	355	355	457	633	839	1.395	1.395	2.094	2.878	3.227
70	373	373	472	660	888	1.510	1.510	2.204	3.015	3.316
75	382	382	526	683	917	1.599	1.599	2.428	3.176	3.513
80	394	394	545	707	950	1.656	1.656	2.591	3.306	3.614
85	405	405	582	723	1.029	1.719	1.719	2.711	3.476	3.832
90	422	422	618	739	1.147	1.728	1.728	2.894	3.651	3.957
95	457	457	644	813	1.216	1.851	1.851	3.028	3.839	4.268
100	472	472	670	855	1.293	1.958	1.958	3.160	4.008	4.346
110	526	526	827	1.050	1.400	2.278	2.278	3.429	4.865	4.780
120	595	595	874	1.110	1.478	2.347	2.347	3.705	4.928	4.963

\* Para calcular la longitud de rosca en estas medidas se utilizará la siguiente fórmula:  $b_2=L-(x_1+3)$   
 (1)  $L \leq 125$   
 (2)  $125 < L \leq 200$

Precios en € por 100 unidades. Medidas indicadas en m/m

## ESPARRAGO ROSCADO EN CADA EXTREMO 1,25 d STUDS, NUT END $\approx 1,25 d$

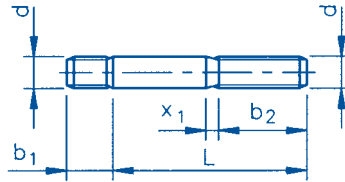

$b_1 \approx 1,25 d$	6,25	7,5	10	12	15	18	20	25	28	30
$b_2 (1)$	14	18	22	26	30	34	38	46	50	54
$b_2 (2)$	20	24	28	32	36	40	44	52	56	60
$x_1$	2	2,5	3,2	3,8	4,3	5	5	6,3	6,3	7,5

d	M-5	M-6	M-8	M-10	M-12	M-14	M-16	M-20	M-22	M-24
L 16	245	245	304							
20	255	255	310	396	515					
25	264	264	333	424	519					
30	281	281	350	442	554	1.061	1.061			
35	290	290	364	479	584	1.117	1.117			
40	296	296	387	496	625	1.135	1.135	1.700		
45	304	304	401	533	656	1.156	1.156	1.707	2.387	
50	318	318	410	565	695	1.189	1.189	1.865	2.498	2.813
55	333	333	435	581	746	1.288	1.288	1.976	2.630	2.975
60	347	347	449	602	776	1.371	1.371	2.011	2.757	3.065
65	355	355	457	633	839	1.395	1.395	2.094	2.878	3.227
70	373	373	472	660	888	1.510	1.510	2.204	3.015	3.316
75	382	382	526	683	918	1.599	1.599	2.428	3.176	3.513
80	392	392	545	707	950	1.656	1.656	2.591	3.306	3.614
85	405	405	586	723	1.029	1.719	1.719	2.711	3.476	3.832
90	422	422	618	739	1.147	1.728	1.728	2.894	3.651	3.957
95	457	457	644	813	1.216	1.851	1.851	3.028	3.839	4.268
100	472	472	670	855	1.293	1.958	1.958	3.160	4.008	4.346
110	526	526	827	1.050	1.400	2.278	2.278	3.429	4.865	4.780
120	595	595	874	1.110	1.478	2.347	2.347	3.705	4.931	4.963

\* Para calcular la longitud de rosca en estas medidas se utilizará la siguiente fórmula:  $b_2=L-(x_1+3)$   
 (1)  $L \leq 125$   
 (2)  $125 < L \leq 200$

Precios en € por 100 unidades. Medidas indicadas en m/m

## TORNILLO CABEZA AVELLANADA PLANA CON RANURA SLOTTED COUNTERSUNK HEAD SCREWS

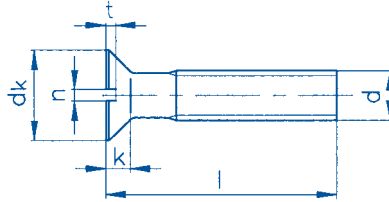

<b>t min.</b>	0,32	0,4	0,5	0,6	0,8	1	1,2	1,6	2	2,4	3,2
<b>n</b>	0,4	0,5	0,6	0,8	1	1,2	1,6	2	2,5	3	4
<b>k</b>	0,96	1,2	1,5	1,65	2,2	2,5	3	4	5	6	8
<b>dk</b>	3	3,8	4,7	5,6	7,5	9,2	11	14,5	18	22	29

<b>d</b>	<b>M-1,6</b>	<b>M-2</b>	<b>M-2,5</b>	<b>M-3</b>	<b>M-4</b>	<b>M-5</b>	<b>M-6</b>	<b>M-8</b>	<b>M-10</b>	<b>M-12</b>	<b>M-16</b>
<b>L 4</b>	54,54	14,60	14,60								
<b>5</b>	52,78	11,08	11,08	6,09							
<b>6</b>	51,02	9,68	9,68	5,26	7,16	14,71					
<b>8</b>	51,02	9,85	9,85	5,26	7,16	13,09	16,63				
<b>10</b>	52,78	10,20	10,20	5,37	6,30	10,03	12,61	47,80			
<b>12</b>	56,30	10,56	10,56	5,54	6,60	10,50	13,34	47,80			
<b>14</b>		11,08	11,08	7,21	8,74	14,95	18,65	35,10			
<b>16</b>		11,96	11,96	6,10	7,55	11,95	14,90	32,49	152		
<b>18</b>		13,37	13,37	8,59	9,89	16,54	20,94	42,93	152		
<b>20</b>		14,78	14,78	7,21	8,41	13,20	16,82	34,41	110		
<b>22</b>				12,03	11,33	19,00	23,66	52,43	148		
<b>25</b>				9,41	9,75	15,20	19,70	41,08	119	322	
<b>30</b>				11,47	11,54	17,95	22,70	47,80	123	322	1.360
<b>35</b>				26,20	15,22	22,85	28,27	63,09	139	350	1.397
<b>40</b>				33,46	18,40	31,54	31,86	67,88	157	389	1.448
<b>45</b>					34,13	35,36	39,41	81,26	185	510	1.524
<b>50</b>					41,08	39,20	43,14	93,70	199	535	1.545
<b>55</b>					62,05	56,40	54,19	137	250	623	1.599
<b>60</b>					62,05	56,40	54,19	137	250	623	1.599
<b>70</b>						87,00	66,24	158	359	739	1.661
<b>80</b>						126	92,89	211	435	873	1.976
<b>90</b>						179	166	325	609	1.042	2.278
<b>100</b>						213	192	468	730	1.256	2.593
<b>110</b>											2.745
<b>120</b>											2.833

Precios en € por 100 unidades. Medidas indicadas en m/m



## TORNILLO CABEZA AVELLANADA ALOMADA CON RANURA SLOTTED RAISED COUNTERSUNK HEAD SCREWS

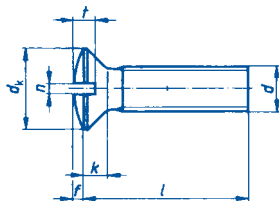

t min.	0,8	1	1,2	1,6	2	2,4	3,2	4
n	0,5	0,6	0,8	1	1,2	1,6	2	2,5
k	1,2	1,5	1,65	2,2	2,5	3	4	5
dk	3,8	4,7	5,6	7,5	9,2	11	14,5	18
F	0,5	0,6	0,75	1	1,2	1,5	2	2,5

d	M-2	M-2,5	M-3	M-4	M-5	M-6	M-8	M-10
L 5	14,95	14,95						
6	15,83	15,83	6,10	8,22				
8	16,54	16,54	6,10	8,22	14,34	19,11		
10	18,12	18,12	6,26	7,27	11,56	14,53	54,49	
12	19,53	19,53	6,49	7,55	12,03	15,29	54,49	
14			8,97	10,82	17,07	21,46	46,62	
16	20,58	20,58	7,07	8,60	13,67	17,21	37,28	174
18			10,20	12,23	19,18	24,28	50,14	174
20	27,45	27,45	8,13	9,75	15,29	19,41	40,15	125
25			12,14	11,19	17,49	21,80	44,93	135
30			13,95	12,72	19,41	24,28	54,49	141
35			26,28	18,16	23,22	32,60	64,06	158
40			33,46	21,99	31,54	37,28	69,79	179
45				42,07	40,15	49,72	93,70	213
50				49,72	44,93	62,14	109	229
60					64,06	84,13	158	289
70					99,44	124	181	413
80					145	172	285	500
90						257	454	625
100						292	538	748

Precios en € por 100 unidades. Medidas indicadas en m/m

**TORNILLO CABEZA AVELLANADA PLANA  
CON MORTAJA CRUZADA H -PHILLIPS-**  
CROSS RECESSED COUNTERSUNK (FLAT) HEAD SCREWS - H

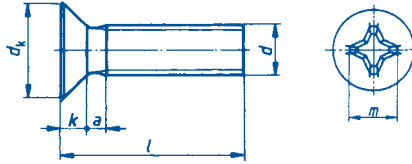

a	0,7	0,8	0,9	1	1,4	1,6	2	2,5	3
k	0,96	1,2	1,5	1,65	2,2	2,5	3	4	5
dk	3	3,8	4,7	5,6	7,5	9,2	11	14,5	18
m	1,7	2,35	2,7	2,9	4,4	4,6	6,6	8,7	9,6

d	M-1,6	M-2	M-2,5	M-3	M-4	M-5	M-6	M-8	M-10
L 4	73,89	14,60	14,60	7,92					
5	73,89	11,08	11,08	5,98	11,26				
6	73,89	9,68	9,68	4,87	8,60	21,46			
8	77,41	9,85	9,85	5,07	8,60	16,54	28,85		
10	82,69	10,20	10,20	5,35	9,08	15,59	21,99	84,62	
12	95,00	10,56	10,56	5,74	10,03	16,54	22,94	63,09	
14		16,89	16,89	7,74	14,43	23,93	33,60	89,55	
16		11,96	11,96	6,21	11,47	18,35	25,81	68,84	
18		20,76	20,76	9,32	15,66	27,45	37,30	96,94	
20		14,78	14,78	7,44	12,42	21,02	28,68	74,58	183
22				13,37	17,95	31,14	40,99	106	
25			17,73	11,00	14,34	23,89	31,54	81,26	201
30				12,42	17,21	27,73	36,33	88,92	220
35				13,72	21,02	29,63	40,15	109	267
40				14,34	23,89	35,36	44,93	115	281
45					32,90	42,07	50,67	133	325
50					32,90	44,93	54,49	139	362
60					51,02	58,46	68,09	181	454
70						116	134	274	
80						147	188	384	
90							262	514	
100							369	677	

Precios en € por 100 unidades. Medidas indicadas en m/m



**TORNILLO CABEZA AVELLANADA ALOMADA  
CON MORTAJA CRUZADA H - PHILLIPS-  
CROSS RECESSED RAISED COUNTERSUNK HEAD SCREWS - H**

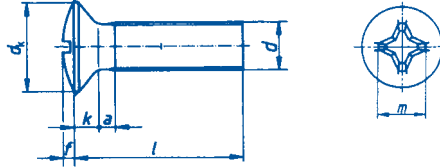

a	0,9	1	1,4	1,6	2	2,5
f	0,6	0,75	1	1,25	1,5	2
k	1,5	1,65	2,2	2,5	3	4
dk	4,7	5,6	7,5	9,2	11	14,5
m	2,7	3,1	4,5	5,3	6,8	9

d	M-2,5	M-3	M-4	M-5	M-6	M-8
L 5	14,60	5,98				
6	13,20	4,87	8,60	18,83		
8	14,43	5,07	8,60	16,54		
10	15,83	5,35	9,08	15,59	21,99	
12	17,07	5,74	10,03	16,54	22,94	62,98
16	18,47	6,21	11,47	18,35	25,81	68,84
20		7,44	12,42	21,02	28,68	74,58
25		11,00	14,34	23,89	31,54	81,26
30		12,42	17,21	27,73	36,33	88,92
35			21,02	29,63	40,15	109
40			23,89	35,36	44,93	115
45				42,07	50,67	133
50				44,93	54,49	139
60				77,40	90,71	186
70				102	127	236
80				151	163	303

Precios en € por 100 unidades. Medidas indicadas en m/m

# DIN 975

ACERO INOXIDABLE - STAINLESS STEEL

**A2**  
aisi 304

## VARILLA ROSCADA WHITWORTH -UNC- THREADED RODS WHITWORTH -UNC-

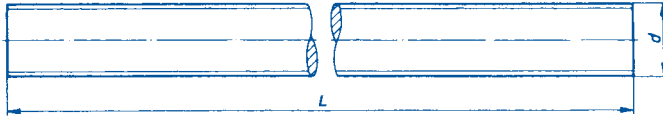

d	PRECIO 1 metro
1/4"	1.524
5/16"	1.951
3/8"	3.047
7/16"	4.770
1/2"	5.172
5/8"	10.320
3/4"	13.316
7/8"	18.132
1"	19.432

Precios en € por 100 unidades. Medidas indicadas en m/m

## VARILLA ROSCADA THREADED RODS

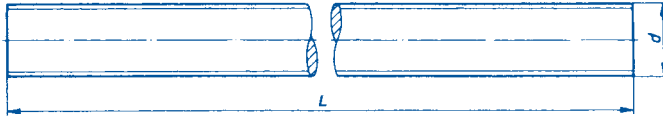

d	PRECIO 1 metro	PRECIO 3 metros
M-2	1.214	
M-2,5	1.214	
M-3	369	
M-4	310	
M-5	289	
M-6	380	1.534
M-8	653	2.621
M-10	1.020	4.082
M-12	1.478	5.911
M-14	2.122	8.487
M-16	2.706	10.823
M-18	3.598	14.391
M-20	4.254	17.016
M-22	5.744	23.153
M-24	6.677	27.059
M-27	9.657	40.387
M-30	12.878	53.273
M-33	18.111	
M-36	25.241	
M-39	35.340	
M-42	49.472	
M-45	60.197	
M-48	87.386	

Precios en € por 100 unidades. Medidas indicadas en m/m



## TUERCA AUTOBLOCANTE METALICA FORMA V PREVAILING TORQUE TYPE HEXAGON NUTS, ALL-METAL NUTS

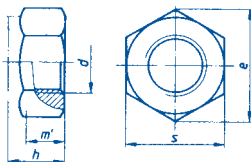

d	s	e	m' min.	h	PRECIO
M-3	5,5	6,01	1,65	3,7	141
M-4	7	7,66	2,2	4,2	82,69
M-5	8	8,79	2,75	5,1	86,21
M-6	10	11,05	3,3	6	91,49
M-8	13	14,38	4,4	8	155
M-10	17	18,9	5,5	10	239
M-12	19	21,1	6,6	12	327
M-14	22	24,49	7,7	14	901
M-16	24	26,75	8,8	16	941
M-18	27	29,56	9,9	18	1.212
M-20	30	32,95	11	20	1.372
M-24	36	39,55	13,2	24	3.316

Precios en € por 100 unidades. Medidas indicadas en m/m

**TUERCA AUTOBLOCANTE FORMA ALTA CON INSERCIÓN NO-METÁLICA**  
 PREVAILING TORQUE TYPE HEXAGON NUTS WITH NON-METALLIC INSERT HIGH TYPE

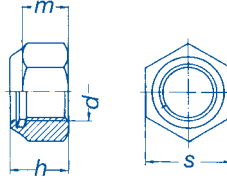

d	s	m min.	h	PRECIO
M-5	8	4,4	6,3	123
M-6	10	4,9	8	150
M-8	13	6,44	9,5	236
M-10	17	8,04	11,5	412
M-12	19	10,37	14	554
M-16	24	14,1	18	989
M-20	30	16,9	22	1.819
M-24	36	20,2	28	3.682

Precios en € por 100 unidades. Medidas indicadas en m/m

## TUERCA AUTOBLOCANTE CON INSERCIÓN NO-METALICA

PREVAILING TORQUE TYPE HEXAGON NUTS WITH NON METALLIC INSERT, LOW TYPE

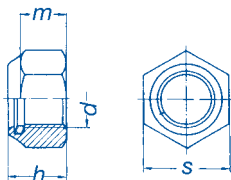

d	s	m min.	h	PRECIO
M-2,5	5	2,3	3,5	41,17
M-3	5,5	2,4	4	6,33
M-4	7	2,9	5	6,69
M-5	8	3,2	5	6,98
M-6	10	4	6	9,24
M-8	13	5,5	8	19,18
M-10	17	6,5	10	41,87
M-12	19	8	12	62,10
M-14	22	9,5	14	120
M-16	24	10,5	16	139
M-18	27	13	18,5	494
M-20	30	14	20	510
M-22	32	15	22	1.374
M-24	36	15	24	1.839
M-27	41	17	27	3.742
M-30	46	19	30	5.005

Precios en € por 100 unidades. Medidas indicadas en m/m



## TUERCA AUTOBLOCANTE UNC CON INSERCIÓN NO-METÁLICA

PREVAILING TORQUE TYPE HEXAGON NUTS, WITH NON METALLIC INSERT, LOW TYPE

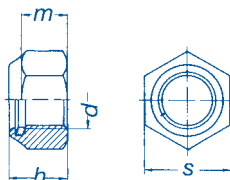

### DIN 985-UNC

d	h	m	s	PRECIO
8.32	6,20	4,20	7,95	347
10.24	6,20	4,20	7,95	347
1/4	8,40	6,40	11,10	232
5/16	10,90	8,80	12,70	443
3/8	12,30	10	14,30	563
1/2	15,30	11,60	19,10	844
5/8	18,80	15,10	23,80	1.358

## TUERCA AUTOBLOCANTE WHITWORTH CON INSERCIÓN NO-METÁLICA

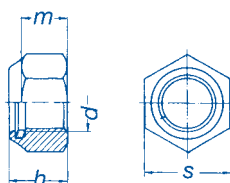

### DIN 985-W

d	h	m	s	PRECIO
3/16	7	4,70	8,20	347
1/4	8,40	6,40	11,30	232
5/16	9,80	7,70	13,35	443
3/8	11,60	9,30	15,25	563
1/2	16,30	12,50	20,80	844
5/8	19,20	19,80	25,60	1.358

Precios en € por 100 unidades. Medidas indicadas en m/m

## TUERCA DE SOMBRERETE AUTOBLOCANTE CON INSERCIÓN NO-METALICA

PREVAILING TORQUE TYPE HEXAGON DOMED CAP NUTS WITH NON METALLIC INSERT

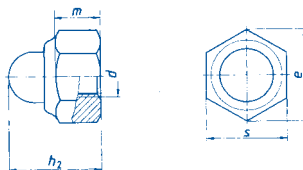

d	s	e	m	h <sub>2</sub>	PRECIO
M-4	7	7,66	2,9	9,6	220
M-5	8	8,79	4,4	10,5	188
M-6	10	11,05	4,9	12	209
M-8	13	14,38	6,44	14	234
M-10	17	18,90	8,04	18,1	375
M-12	19	21,10	10,37	22,5	1.020
M-16	24	26,75	14,1	27,5	1.902
M-20	30	32,95	16,9	35,5	2.947

Precios en € por 100 unidades. Medidas indicadas en m/m

## ARANDELA PARA PERNOS WASHERS FOR CLEVIS PINS, FINISH MEDIUM

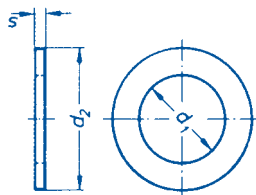

d <sub>1</sub>	d <sub>2</sub>	s	PRECIO
3	6	0,8	98,52
4	8	0,8	98,52
5	10	0,8	75,65
6	12	1,6	89,73
7	14	1,6	144
8	16	2	153
10	20	2,5	209
12	25	3	294
13	25	3	385
14	28	3	415
16	28	3	424
18	30	4	547
20	32	4	602
22	34	4	472
23	36	4	714
24	38	4	760
25	40	4	804
26	40	5	1.144
27	40	5	1.487
28	42	5	1.606
30	45	5	1.673
32	50	5	1.895
33	50	5	1.953
35	52	6	2.859
36	52	6	3.077
40	58	6	3.385

Precios en € por 100 unidades. Medidas indicadas en m/m

## ARANDELA PARA PERNOS WASHERS FOR CLEVIS PINS

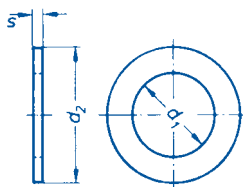

$d_1$	$d_2$	s	PRECIO
5,5	10	0,8	137
7	12	1,6	144
8	14	1,6	153
9	16	2	162
11	20	2,5	297
13	25	3	385
14	25	3	415
15	28	3	456
17	28	3	486
19	30	4	556
21	32	4	610
23	34	4	714
24	36	4	797
25	38	4	883
26	40	4	943
27	40	5	1.027
28	40	5	1.073
29	42	5	1.149
31	45	5	1.205

Precios en € por 100 unidades. Medidas indicadas en m/m



## PASADOR CONICO ESTRIADO

GROOVED PINS, FULL TAPER GROOVED

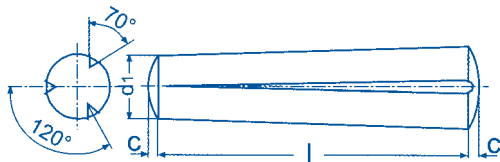

c	0,25	0,4	0,5	0,6	0,8	1

d1	2	3	4	5	6	8
L 8	24,10	32,02	43,98	59,82		
10	28,15	32,02	45,74	59,82	80,93	169
12	28,68	35,19	49,26	68,61	96,76	185
16	28,85	36,95	52,78	75,65	120	201
18	31,32	38,71	52,78	80,93	130	213
20	33,43	38,71	56,30	84,45	153	225
25		40,46	65,10	93,24	176	280
30			72,13	100	192	352
35			75,65	120	209	401
40			84,45	153	225	440
45					271	496
50					296	519
60						568

Precios en € por 100 unidades. Medidas indicadas en m/m



## PASADOR CILÍNDRICO ESTRIADO GROOVED PINS, FULL GROOVED WITH PILOTS

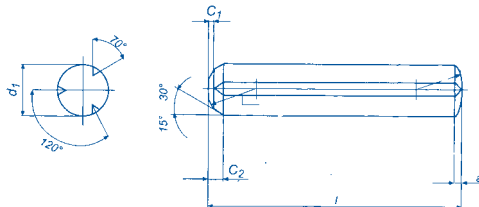

a	0,25	0,4	0,5	0,63	0,8	1
c <sub>2</sub>	0,8	1,2	1,4	1,7	2,1	2,6
c <sub>1</sub> ≈	0,18	0,3	0,4	0,5	0,6	0,8

d <sub>1</sub>	2	3	4	5	6	8
L 8	24,10	32,02	43,98	59,82		
10	28,15	32,02	45,74	59,82	80,93	169
12	28,68	35,19	49,26	68,61	96,76	185
16	28,85	36,95	52,78	75,65	121	201
18	31,14	38,71	52,78	80,93	135	213
20	33,43	38,71	56,30	84,45	153	225
25		40,46	65,10	95,00	176	280
30			72,13	100,28	192	352
35			75,65	121	209	401
40			84,45	153	225	440
45					271	496
50					296	519
60						568

Precios en € por 100 unidades. Medidas indicadas en m/m

## PASADOR ELÁSTICO SLOTTED SPRING PINS, HEAVY DUTY



a	0,15	0,25	0,35	0,4	0,5	0,6	0,65	0,8	0,9	1,2	2	2
s	0,2	0,3	0,4	0,5	0,6	0,75	0,8	1	1	1,25	1,5	2
d <sub>2</sub> ≈	0,8	1,1	1,5	1,8	2,1	2,3	2,8	2,9	3,4	3,9	5,5	6,5
d <sub>1</sub> min.	1,2	1,7	2,3	2,8	3,3	3,8	4,4	4,9	5,4	6,4	8,5	10,5

Ø	1	1,5	2	2,5	3	3,5	4	4,5	5	6	8	10
L 4	54,54	54,54	56,30	59,82	66,85	96,76	102					
5	56,30	56,30	58,06	63,34	72,13	100	106					
6	58,06	58,06	59,82	66,85	77,41	104	109	121	134			
8	59,82	59,82	61,58	70,37	86,21	116	120	139	150			
10	63,34	63,34	65,10	73,89	96,76	120	125	150	167	225	331	493
12	65,10	65,10	70,37	80,93	107	134	139	164	188	239	347	515
14	68,61	68,61	79,17	89,73	123	148	153	181	206	250	362	556
16	72,13	72,13	89,73	98,52	135	157	164	195	222	259	376	593
18	75,65	75,65	96,76	107	143	172	179	211	243	315	450	684
20	80,93	80,93	104	111	151	186	194	232	259	357	515	764
22			109	125	162	199	209	245	278	385	584	917
24			116	130	171	211	220	260	297	406	621	948
26			121	139	179	222	232	273	315	440	646	975
28			128	148	195	230	243	294	347	477	702	1.036
30			137	157	202	239	250	317	369	505	742	1.128
32					213	257	267	329	387	542	813	1.214
36					239	281	292	391	426	598	878	1.337
40					289	313	325	417	468	739	1.071	1.610
45							359	456	505	852	1.173	1.705
50							392	494	563	969	1.247	1.976
55									968	1.129	1.407	2.120
60									1.216	1.253	1.561	2.247
65									1.263	1.311	1.689	2.393
70									1.386	1.420	1.835	2.553
75										1.492	2.002	2.644
80										1.534	2.183	2.738

Precios en € por 100 unidades. Medidas indicadas en m/m

**TUERCA CIEGA FORMA ALTA**  
HEXAGON DOMED CAP NUTS, HIGH TYPE

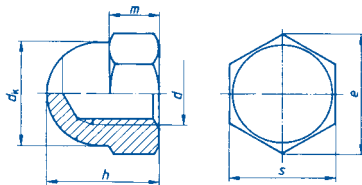

d	s	e	dk max.	m max.	h	PRECIO
M-3	5,5	6,01	5,5	2,4	7	64,04
M-4	7	7,66	6,5	3,2	8	41,10
M-5	8	8,79	7,5	4	10	33,46
M-6	10	11,05	9,5	5	12	35,36
M-8	13	14,38	12,5	6,5	15	66,93
M-10	17	18,9	16	8	18	129
M-12	19	21,1	18	10	22	195
M-14	22	24,49	21	11	25	744
M-16	24	26,75	23	13	28	906
M-18	27	30,14	26	15	32	1.624
M-20	30	33,53	28	16	34	1.663
M-22	34	37,72	33	18	39	4.622
M-24	36	39,98	34	19	42	5.616
M-27	41	47,3	40	20	47	9.349
M-30	46	52	42	24	52	12.943

Precios en € por 100 unidades. Medidas indicadas en m/m

## ARANDELA DE RESORTE DISC SPRINGS

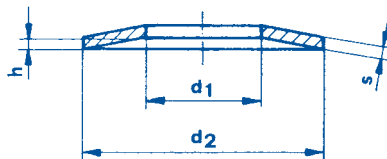

$d_1$	$d_2$	$s$	$h$	PRECIO
3,2	6	0,3	0,45	153
3,2	8	0,5	0,7	153
4,2	8	0,3	0,5	158
4,2	8	0,4	0,6	158
5,2	10	0,4	0,65	172
5,2	10	0,5	0,7	172
4,2	12	0,4	0,8	216
4,2	12	0,5	0,8	216
6,2	12	0,5	0,85	216
6,2	12,5	0,5	0,85	243
6,2	12,5	0,7	0,95	243
7,2	14	0,8	1,1	255
8,2	15	0,8	1,25	266
8,2	16	0,6	1,05	266
8,2	16	0,9	1,25	266
9,2	18	0,7	1,2	357
9,2	18	1	1,4	357
8,2	20	0,5	1,15	410
10,2	20	0,6	1,2	410
10,2	20	0,8	1,35	410
10,2	20	0,9	1,4	447
10,2	20	1	1,55	447
10,2	20	1,1	1,55	447
12,2	25	0,9	1,6	672
12,2	25	1,5	1,6	672
14,2	28	1	1,8	760
14,2	28	1,5	2,15	760

Precios en € por 100 unidades. Medidas indicadas en m/m

## TUERCA EXAGONAL 1,5 d HEXAGON NUTS 1,5 d

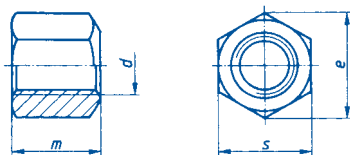

### DIN 6330

d	s	e	m	PRECIO
M-8	13	15	12	424
M-10	17	19,6	15	630
M-12	19	21,9	18	846
M-16	24	27,7	24	1.362
M-20	30	34,6	30	2.241
M-24	36	41,6	36	3.934
M-30	46	53,1	45	6.839
M-36	55	63,5	54	12.808
M-42	65	75	63	20.584

## TUERCA EXAGONAL 1,5 d CON COLLAR HEXAGON NUTS 1,5 d WITH COLLAR

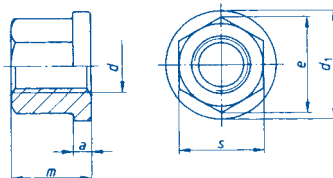

### DIN 6331

d	s	e	m	d <sub>1</sub>	a	PRECIO
M-8	13	15	12	18	3,5	1.019
M-10	17	19,6	15	22	4	1.209
M-12	19	21,9	18	25	4	1.590
M-14	21	23,3	21	28	5	2.261
M-16	24	27,7	24	31	5	2.516
M-20	30	34,6	30	37	6	4.002
M-24	36	41,6	36	45	6	6.598
M-30	46	53,1	45	58	8	12.351
M-36	55	63,5	54	68	10	21.728

Precios en € por 100 unidades. Medidas indicadas en m/m

## ARANDELA CÓNICA ELÁSTICA CONICAL SPRING WASHERS FOR BOLTED CONNECTIONS

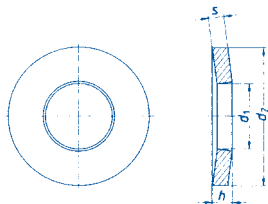

M	d <sub>1</sub>	d <sub>2</sub>	h max.	h min.	s	PRECIO
3	3,2	7	0,85	0,72	0,6	343
4	4,3	9	1,30	1,12	1	352
5	5,3	11	1,55	1,35	1,2	371
6	6,4	14	2	1,70	1,5	378
8	8,4	18	2,60	2,24	2	385
10	10,5	23	3,20	2,80	2,5	547
12	13	29	3,95	3,43	3	713
14	15	35	4,65	4,04	3,5	989
16	17	39	5,25	4,58	4	1.098
18	19	42	5,80	5,08	4,5	1.235
20	21	45	6,40	5,60	5	1.645
22	23	49	7,05	6,15	5,5	2.607
24	25	56	7,75	6,77	6	3.005

Precios en € por 100 unidades. Medidas indicadas en m/m

## ARANDELA DENTADA FORMA A / ARANDELA DENTADA FORMA J TOOTHED LOCK WASHERS FORM A / TOOTHED LOCK WASHERS FORM J

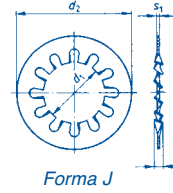
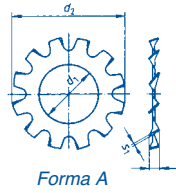

M	d <sub>1</sub>	d <sub>2</sub>	s <sub>1</sub>	PRECIO
2	2,2	4,5	0,3	6,51
2,3	2,5	5	0,4	6,51
2,5	2,7	5,5	0,4	6,51
3	3,2	6	0,4	5,63
4	4,3	8	0,5	7,04
5	5,3	10	0,6	10,03
6	6,4	11	0,7	11,96
7	7,4	12,5	0,8	16,71
8	8,4	15	0,8	19,35
10	10,5	18	0,9	32,02
12	13	20,5	1	40,46
14	15	24	1	59,82
16	17	26	1,2	73,89
18	19	30	1,4	127
20	21	33	1,4	157
22	23	36	1,5	181
24	25	38	1,5	204
27	28	44	1,6	278
30	31	48	1,6	329

Precios en € por 100 unidades. Medidas indicadas en m/m

## ARANDELA DENTADA FORMA A / FORMA J / FORMA V SERRATED LOCK WASHERS FORM A / FORM J / FORM V

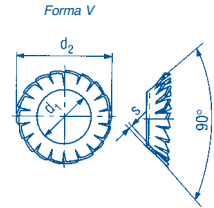
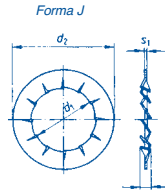
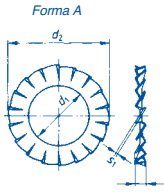

M	d1	d2	s1	PRECIO 6798-A	PRECIO 6798-J	PRECIO 6798-V
2	2,2	4,5	0,3	7,74		
2,3	2,5	5	0,4	7,74		
2,5	2,7	5,5	0,4	7,74		
3	3,2	6	0,4	2,41	4,57	
4	4,3	8	0,5	2,64	5,63	14,95
5	5,3	10	0,6	3,08	6,33	25,16
6	6,4	11	0,7	3,45	7,04	30,96
7	7,4	12,5	0,8	10,20	15,31	
8	8,4	15	0,8	6,95	11,44	56,30
10	10,5	18	0,9	11,26	20,76	93,24
12	13	20,5	1	14,25	25,25	137
14	15	24	1	21,99	39,06	
16	17	26	1,2	28,33	47,50	
18	19	30	1,4	53,31	84,45	
20	21	33	1,4	67,21	98,52	
22	23	36	1,5	84,62	164	
24	25	38	1,5	98,52	179	
27	28	44	1,6	151		
30	31	48	1,6	190		

Precios en € por 100 unidades. Medidas indicadas en m/m



## ANILLO DE SEGURIDAD PARA EJES RETAINING WASHERS FOR SHAFTS

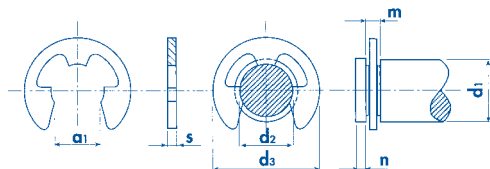

d <sub>2</sub>	d <sub>1</sub>		n min.	m	d <sub>3</sub> max.	S	a <sub>1</sub>	PRECIO
	de	hasta						
1,9	2,5	3	1	0,54	4,8	0,5	1,61	11,50
2,3	3	4	1	0,64	6,3	0,6	1,94	13,50
3,2	4	5	1	0,64	7,3	0,6	2,7	14,70
4	5	7	1,2	0,74	9,3	0,7	3,34	17,30
5	6	8	1,2	0,74	11,3	0,7	4,11	23,00
6	7	9	1,2	0,74	12,3	0,7	5,26	26,50
7	8	11	1,5	0,94	14,3	0,9	5,84	33,80
8	9	12	1,8	1,05	16,3	1	6,52	41,50
9	10	14	2	1,15	18,8	1,1	7,63	62,40
10	11	15	2	1,25	20,4	1,2	8,32	77,00
12	13	18	2,5	1,35	23,4	1,3	10,45	112
15	16	24	3	1,55	29,4	1,5	12,61	165

Precios en € por 100 unidades. Medidas indicadas en m/m

## TORNILLO CILÍNDRICO CON EXÁGONO INTERIOR CABEZA BAJA CON GUIA DE LLAVE

SOCKET HEAD CAP SCREWS, LOW HEAD-PILOT RECESS

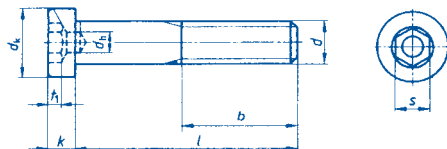

<b>b</b>	14	16	18	22	26	30	38	46	54
<b>s</b>	3	4	5	6	8	10	14	17	19
<b>k max.</b>	2,8	3,5	4	5	6,5	7,5	10	12	14
<b>dk max.</b>	7	8,5	10	13	16	18	24	30	36
<b>t<sub>1</sub> min.</b>	1,48	1,88	2,38	2,88	3,35	3,85	5,35	6,32	7

<b>d</b>	<b>M- 4</b>	<b>M-5</b>	<b>M-6</b>	<b>M-8</b>	<b>M-10</b>	<b>M-12</b>	<b>M-16</b>	<b>M-20</b>	<b>M-24</b>
<b>L 6</b>	121								
<b>8</b>	89,73	139	186						
<b>10</b>	73,89	102	128	172					
<b>12</b>	73,89	102	128	172	500				
<b>16</b>	77,41	80,93	102	134	419	642			
<b>20</b>	82,69	86,21	111	150	359	577			
<b>25</b>	87,97	91,49	116	169	338	519	2.148		
<b>30</b>	100	107	127	178	369	528	2.087	4.831	
<b>35</b>		139	144	199	387	559	2.087	4.831	
<b>40</b>		153	157	220	413	612	2.157	4.198	
<b>45</b>		179	222	253	470	674	2.245	4.268	
<b>50</b>		204	245	287	517	728	2.315	4.391	8.526
<b>55</b>			334	438	625	855	2.509	4.655	8.526
<b>60</b>		297	334	438	625	855	2.562	4.831	8.526
<b>70</b>		364	419	496	739	934	2.799	5.289	9.054
<b>80</b>				642	857	1.059	3.045	6.415	9.054
<b>90</b>				823	1.258	1.529	3.313	7.576	9.757
<b>100</b>				943	1.601	2.060	3.686	9.001	10.813
<b>110</b>							7.928	12.924	11.868
<b>120</b>							8.068	13.100	14.419
<b>130</b>							8.209	13.276	14.859
<b>140</b>							8.350	13.452	15.211
<b>150</b>							8.491	13.628	15.387

Precios en € por 100 unidades. Medidas indicadas en m/m



## REMACHES BLINDRIVETS

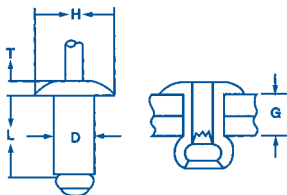

D	L	H	T	G max.	Ø AGUJERO	PRECIO
3,2	6	6,3	0,9	1-3,2	3,3	33,60
	8	6,3	0,9	3,2-4,8	3,3	35,54
	10	6,3	0,9	4,8-6,4	3,3	40,11
	12	6,3	0,9	6,4-9,6	3,3	45,21
	15	6,3	0,9	9,6-12	3,3	55,95
4	6	8	1,1	1,2-3,2	4,1	39,06
	8	8	1,1	3,2-4,8	4,1	42,05
	10	8	1,1	4,8-6,4	4,1	46,80
	12	8	1,1	6,4-8,2	4,1	56,65
	14	8	1,1	8,2-10,2	4,1	60,52
	16	8	1,1	9,5-12,1	4,1	64,39
	18	8	1,1	11-13,6	4,1	73,01
	20	8	1,1	13,5-15,9	4,1	84,98
4,8	8	9,5	1,3	1,2-3,2	4,9	59,11
	10	9,5	1,3	3,2-6	4,9	64,22
	12	9,5	1,3	6 - 8	4,9	70,20
	14	9,5	1,3	7,5-10	4,9	76,00
	17	9,5	1,3	10-13	4,9	84,10
	20	9,5	1,3	13-16	4,9	103
	24	9,5	1,3	16-20	4,9	129
	30	9,5	1,3	20-26	4,9	143

Precios en € por 100 unidades. Medidas indicadas en m/m

## PASADOR ELÁSTICO EN ESPIRAL

### SPIRAL PINS

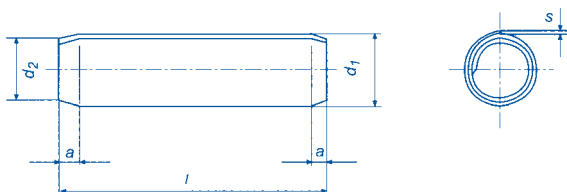

<b>a</b> ≈	0,3	0,5	0,7	0,8	1	1,3	1,7	2	3
<b>s</b>	0,08	0,13	0,17	0,21	0,25	0,33	0,42	0,5	0,67
<b>d<sub>1</sub></b>	1,1	1,62	2,15	2,65	3,15	4,2	5,25	6,25	8,35
<b>d<sub>2</sub></b>	0,95	1,4	1,9	2,35	2,85	3,8	4,8	5,8	7,75

Ø	1	1,5	2	2,5	3	4	5	6	8
<b>L 4</b>	31,14	31,14	31,67						
<b>5</b>	31,67	31,67	32,20	35,19					
<b>6</b>	32,20	32,20	32,72	36,95					
<b>8</b>	32,72	32,72	34,13	38,71	47,50	65,10			
<b>10</b>	34,31	34,31	35,71	38,71	52,78	68,61	89,73		
<b>12</b>	35,54	35,54	37,12	40,46	54,54	77,41	104	121	
<b>14</b>	36,95	36,95	38,71	42,22	59,82	84,45	113	134	
<b>16</b>		38,71	40,46	45,74	65,10	98,52	134	150	164
<b>18</b>			42,22	47,50	66,85	104	143	157	197
<b>20</b>			43,98	52,78	68,61	114	150	172	204
<b>22</b>				54,54	77,41	123	165	183	222
<b>24</b>				58,06	84,45	128	179	195	238
<b>26</b>					87,97	135	188	215	257
<b>28</b>					95,00	141	195	225	274
<b>30</b>					96,76	146	209	248	287
<b>32</b>					98,52	157	225	255	327
<b>36</b>						164	238	283	347
<b>40</b>						179	267	313	366
<b>45</b>						209	297	334	424
<b>50</b>						225	313	364	450

Precios en € por 100 unidades. Medidas indicadas en m/m



### ARANDELA PLANA PARA TORNILLOS CON PASADOR ELÁSTICO WASHERS FOR BOLTS WITH HEAVY TYPE SPRING PINS

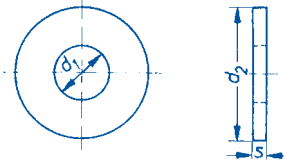

M	d <sub>1</sub>	d <sub>2</sub>	s	PRECIO
3	3,2	9	1	28,15
4	4,3	12	1,6	31,67
5	5,3	15	2	38,71
6	6,4	17	3	75,65
8	8,4	21	4	153
10	10,5	25	4	206
12	13	30	6	586
14	15	36	6	776
16	17	40	6	913
18	19	44	8	1.330
20	21	44	8	1.346
22	23	50	8	2.088
24	25	50	10	2.537
27	28	60	10	2.986
30	31	68	10	3.431

Precios en € por 100 unidades. Medidas indicadas en m/m

Tel. 93 729 99 60 - Fax 93 729 99 61



## TORNILLO CABEZA ALOMADA CON EXÁGONO INTERIOR "ULS" BUTTON HEAD SCREWS "ULS"

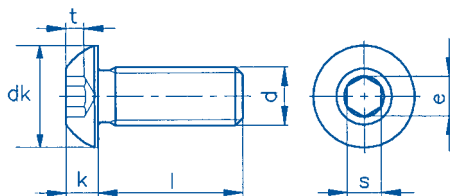

<b>k max.</b>	1,65	2,2	2,75	3,3	4,3	5,3	6,6
<b>t</b>	1,04	1,3	1,56	2,08	2,60	3,12	4,16
<b>e min.</b>	2,3	2,87	3,44	4,58	5,72	6,86	9,15
<b>s</b>	2	2,5	3	4	5	6	8
<b>dk</b>	5,7	7,6	9,5	10,5	14	17,5	21

<b>d</b>	<b>M-3</b>	<b>M-4</b>	<b>M-5</b>	<b>M-6</b>	<b>M-8</b>	<b>M-10</b>	<b>M-12</b>
<b>L 5</b>	18,82						
<b>6</b>	15,13	15,31	21,82				
<b>8</b>	15,13	13,37	18,82	31,32			
<b>10</b>	15,13	13,72	19,00	27,80	66,50		
<b>12</b>	15,48	14,43	19,70	27,97	66,50		
<b>16</b>	18,12	16,19	22,70	28,59	57,35	128	
<b>20</b>	21,82	19,00	28,77	32,20	61,22	128	310
<b>25</b>	24,28	21,99	32,72	35,89	69,67	108	385
<b>30</b>	28,50	30,08	36,07	41,34	78,82	119	412
<b>35</b>		34,48	38,18	47,15	87,26	137	429
<b>40</b>		38,18	44,69	52,60	94,12	142	470
<b>45</b>			64,04	60,87	105	156	508
<b>50</b>			71,08	77,76	115	165	545
<b>55</b>				88,76	129	216	616
<b>60</b>			84,27	88,76	129	216	649
<b>65</b>				109	165	255	778
<b>70</b>			96,76	109	165	255	934
<b>75</b>				147	208	320	1.121
<b>80</b>				173	227	345	1.198

Precios en € por 100 unidades. Medidas indicadas en m/m



## TORNILLO CABEZA ALOMADA CON COLLAR BISELADO Y EXÁGONO INTERIOR BUTTON HEAD SCREWS "ULS" WITH FLANGE

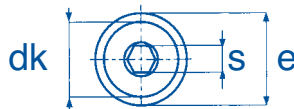
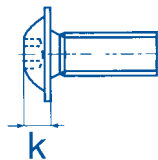

<b>e</b>	6,90	9,35	11,80	13,85	17,90	21,90
<b>k</b>	1,60	2,10	2,70	3,30	4,40	5,30
<b>dk</b>	5,50	7,50	9,50	10,50	14	18
<b>s</b>	2	2,5	3	4	5	6

<b>d</b>	<b>M-3</b>	<b>M-4</b>	<b>M-5</b>	<b>M-6</b>	<b>M-8</b>	<b>M-10</b>
<b>L 6</b>	80,93					
<b>8</b>	84,45	84,45				
<b>10</b>	87,97	87,97	130	174		
<b>12</b>	95,00	95,00	135	179	350	
<b>16</b>	104	104	148	192	350	
<b>20</b>	121	121	164	208	375	792
<b>25</b>			197	230	424	853
<b>30</b>			218	255	479	925
<b>35</b>				283	519	1.005
<b>40</b>				301	563	1.091
<b>45</b>					633	1.210
<b>50</b>					700	1.330
<b>60</b>						1.582

Precios en € por 100 unidades. Medidas indicadas en m/m



### TORNILLO TRILOBULAR AUTOROSCANTE CABEZA CILÍNDRICA THREAD ROLLINGCROSS RECESSED RAISED CHEESE HEAD SCREWS

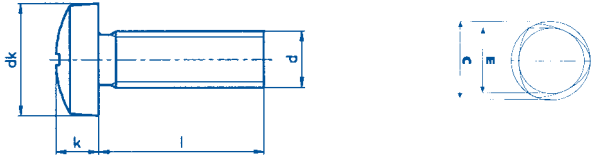

<b>c max.</b>	2,57	3,07	4,08	5,09	6,10
<b>dk</b>	5	6	8	10	12
<b>k</b>	2	2,4	3,1	3,8	4,6
<b>Nr pozidriv</b>	1	1	2	2	3
<b>E</b>	2,35	2,84	3,75	4,70	5,60

<b>d</b>	<b>M-2,5</b>	<b>M-3</b>	<b>M-4</b>	<b>M-5</b>	<b>M-6</b>
<b>L 5</b>	36,42	38,53			
<b>6</b>	36,42	39,59	52,25		
<b>8</b>	38,00	41,70	58,06	87,61	
<b>10</b>	38,00	47,85	59,82	96,06	155
<b>12</b>		52,25	67,56	103	164
<b>16</b>		54,89	81,81	121	167
<b>20</b>		63,34	91,84	145	183
<b>25</b>			98,70	153	209
<b>30</b>			113	169	222

Precios en € por 100 unidades. Medidas indicadas en m/m

## TORNILLO TRILOBULAR AUTOROSCANTE CABEZA AVELLANADA PLANA THREAD ROLLING CROSS RECESSED COUNTERSUNK HEAD SCREWS

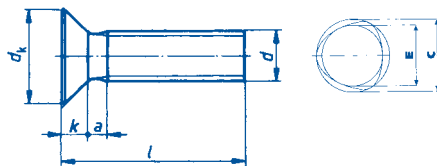

C max.	2,57	3,07	4,08	5,09	6,10
dk	4,7	5,6	7,5	9,2	14,5
k (max.)	1,5	1,65	2,2	2,5	4
Nr. pozidriv	1	1	2	2	3
E	2,35	2,84	3,75	4,70	5,60

d	M-2,5	M-3	M-4	M-5	M-6
L 5	32,72				
6	33,43	35,89			
8	35,19	38,00	52,25		
10	36,95	41,17	52,78	70,73	
12	41,17	44,34	57,53	75,65	113
16		46,45	67,56	97,12	137
20			79,17	116	143
25				145	153
30				158	172

Precios en € por 100 unidades. Medidas indicadas en m/m



# DIN 7504-K

ACERO INOXIDABLE - STAINLESS STEEL

A2  
aisi 304

## TORNILLO PUNTA BROCA CABEZA EXAGONAL SELF DRILLING SCREWS WITH HEXAGON HEAD

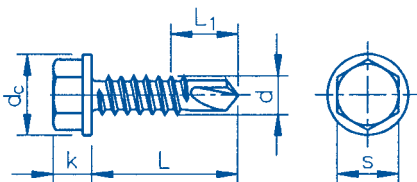

<b>dc</b>	8,8	10,5	11	13,2
<b>k (max.)</b>	4,25	4,45	5,45	6,45
<b>s</b>	7	8	8	10
<b>L1 <math>\approx</math></b>	7	8	10	11

<b>d</b>	<b>4,2</b>	<b>4,8</b>	<b>5,5</b>	<b>6,3</b>
<b>L 13</b>	40,46	45,74		
<b>16</b>	42,22	50,14		
<b>19</b>	44,86	52,78	91,49	139
<b>22</b>	48,38	56,30	99,40	150
<b>25</b>	51,90	60,70	107	159
<b>32</b>	60,70	71,25	123	186
<b>38</b>	71,25	74,77	140	208
<b>45</b>		82,69	161	236
<b>50</b>		93,50	187	254
<b>70</b>			267	
<b>80</b>			297	

Precios en € por 100 unidades. Medidas indicadas en m/m

## TORNILLO PUNTA BROCA CABEZA CILÍNDRICA SELF DRILLING SCREWS WITH PAN HEAD

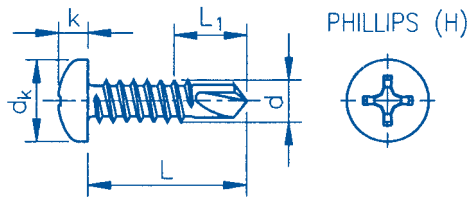

<b>dk</b>	5,6	6,9	7,5	8,2	9,5
<b>k</b>	2,2	2,6	2,8	3,05	3,55
<b>L<sub>1</sub> ≈</b>	4,5	5	6	7	8

<b>d</b>	<b>2,9</b>	<b>3,5</b>	<b>3,9</b>	<b>4,2</b>	<b>4,8</b>
<b>L 9,5</b>	28,15	26,39	29,91		
<b>13</b>	26,39	26,39	29,91	40,46	45,74
<b>16</b>	29,91	29,91	30,79	42,22	50,14
<b>19</b>		30,79	33,43	44,86	52,78
<b>22</b>		33,43	38,71	48,38	56,30
<b>25</b>		34,31	43,98	51,90	60,70
<b>32</b>			52,78	60,70	71,25
<b>38</b>			66,85	71,25	74,77
<b>45</b>					82,69
<b>50</b>					93,24
<b>60</b>					107

Precios en € por 100 unidades. Medidas indicadas en m/m

## TORNILLO PUNTA BROCA CABEZA AVELLANADA PLANA

### SELF DRILLING SCREWS WITH COUNTERSUNK HEAD

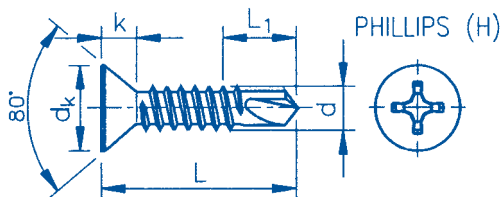

dk	6,8	7,5	8,1	9,5
k ≈	2,1	2,3	2,5	3
L <sub>1</sub> ≈	5	6	7	8

d	3,5	3,9	4,2	4,8
L 13	26,39	29,91	40,46	45,74
16	29,91	30,79	42,22	50,14
19	30,79	33,43	44,86	52,78
22	33,43	38,71	48,38	56,30
25	34,31	43,98	51,90	60,70
32		52,78	60,70	71,25
38		66,85	71,25	74,77
45				82,69
50				93,24

Precios en € por 100 unidades. Medidas indicadas en m/m

## TORNILLO PARA AGLOMERADO Y MADERA CABEZA AVELLANADA PLANA MORTAJA Z - POZIDRIVE

COUNTERSUNK HEAD CROSS-RECESSED CHIPBOARDSCREWS, POZIDRIVE

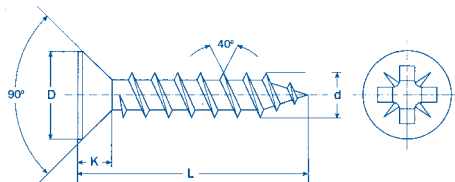

D	6	7	8	9	10	12
K	1,5	1,75	2	2,25	2,5	3

d	3	3,5	4	4,5	5	6
L 12	15,13	16,01	17,24			
16	11,08	12,67	15,31			
20	11,96	13,37	16,19	23,58	24,28	
25	12,58	14,25	17,24	21,11	25,33	58,06
30	13,37	14,95	17,95	23,05	26,92	51,90
35	16,36	17,42	20,94	24,98	30,26	55,95
40	18,30	18,65	22,52	26,39	32,72	58,94
45			23,75	29,38	37,83	61,58
50		21,70	24,98	32,02	39,59	65,10
60			38,71	47,50	54,54	72,13
70			43,98	58,06	70,37	91,49
80				77,41	84,45	111
90					116	151
100					153	199
110					234	259
120					294	336
130						438
140						568
150						739

Precios en € por 100 unidades. Medidas indicadas en m/m

## TORNILLO PARA AGLOMERADO Y MADERA CABEZA CILINDRICA ALOMADA MORTAJA Z - POZIDRIVE

PAN HEAD CHIPBOARDSCREWS, POZIDRIVE

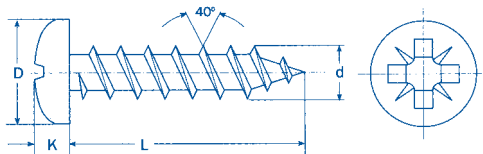

D	6	7	8	9	10	12
k	2,25	2,60	2,80	3	3,50	4,20

d	3	3,5	4	4,5	5	6
L 16	13,37	19,00	19,18			
20	14,43	15,31	19,53	28,33	29,20	
25	15,13	17,24	20,76	25,33	30,26	68,61
30	16,19	17,95	21,64	27,80	32,37	63,34
35	20,76	21,64	25,16	30,08	36,42	66,85
40	21,99	22,70	26,74	31,67	39,23	70,37
45		28,50	35,36	45,39	73,89	
50		30,08	38,35	47,50	77,41	77,41
60		45,74	56,30	65,10	86,21	86,21
70		52,78	68,61	84,45	109	109
80			93,24	102	132	132
90				139	181	181
100				185	239	239
110					310	
120					403	

Precios en € por 100 unidades. Medidas indicadas en m/m



## TORNILLO ROSCA CHAPA CABEZA CILÍNDRICA FORMA C SLOTTED PAN HEAD TAPPING SCREWS

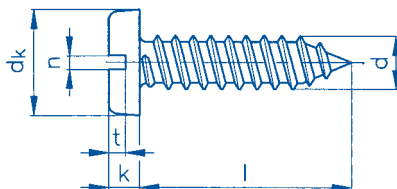

<b>t max.</b>	0,8	1	1,25	1,4	1,5	1,7	1,95	2,2
<b>n</b>	0,6	0,8	1	1	1,2	1,2	1,6	1,6
<b>k max.</b>	1,35	1,75	2,1	2,25	2,45	2,8	3,2	3,65
<b>dk max.</b>	4,2	5,6	6,9	7,5	8,2	9,5	10,8	12,5

<b>d</b>	<b>2,2</b>	<b>2,9</b>	<b>3,5</b>	<b>3,9</b>	<b>4,2</b>	<b>4,8</b>	<b>5,5</b>	<b>6,3</b>
<b>L n°</b>	<b>2</b>	<b>4</b>	<b>6</b>	<b>7</b>	<b>8</b>	<b>10</b>	<b>12</b>	<b>14</b>
<b>6,5 1/4"</b>	25,51	4,35	5,35	6,79	7,16			
<b>9,5 3/8"</b>	25,51	4,57	5,49	6,40	6,69	11,47		
<b>13 1/2"</b>	26,57	4,96	5,74	6,69	7,44	10,50	16,24	40,15
<b>16 5/8"</b>	30,08	5,30	6,21	7,44	7,93	11,47	17,21	40,15
<b>19 3/4"</b>	35,19	5,82	6,69	7,83	8,80	12,90	19,11	38,23
<b>22 7/8"</b>	40,46	7,16	8,13	8,60	10,15	14,34	21,02	39,20
<b>25 1"</b>	52,78	8,13	9,13	9,61	11,00	15,29	21,99	41,10
<b>32 1 1/4"</b>		12,61	11,47	12,81	13,51	18,16	25,81	46,85
<b>38 1 1/2"</b>			13,86	15,76	16,63	21,99	31,14	52,60
<b>45 1 3/4"</b>				22,70	24,86	32,49	39,50	68,84
<b>50 2"</b>				25,51	28,68	34,41	43,33	72,66
<b>60 2 3/8"</b>					45,92	51,62	63,09	123
<b>70 2 3/4"</b>					58,52	64,06	79,52	147
<b>80 3 1/8"</b>					91,13	97,82	110	160
<b>90 3 1/2"</b>						135	157	201
<b>100 4"</b>						149	172	241

Precios en € por 100 unidades. Medidas indicadas en m/m



## TORNILLO ROSCA CHAPA CABEZA AVELLANADA PLANA FORMA C SLOTTED COUNTERSUNK HEAD TAPPING SCREWS

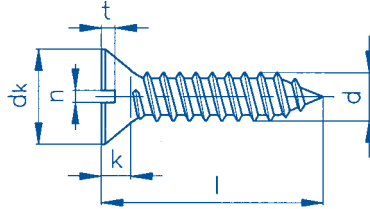

t max.	0,6	0,75	0,95	1,05	1,15	1,35	1,5	1,75
n	0,6	0,8	1	1	1,2	1,2	1,6	1,6
k max.	1,3	1,7	2,1	2,3	2,5	3	3,4	3,8
dk max.	4,3	5,5	6,8	7,5	8,1	9,5	10,8	12,4

d		2,2	2,9	3,5	3,9	4,2	4,8	5,5	6,3
L	nº	2	4	6	7	8	10	12	14
6,5	1/4"	25,51	4,35	5,35	6,79	7,16			
9,5	3/8"	25,51	4,57	5,49	6,40	6,69	11,47		
13	1/2"	26,57	4,96	5,74	6,69	7,44	10,50	16,24	40,15
16	5/8"	30,08	5,30	6,21	7,44	7,93	11,47	17,21	40,15
19	3/4"	35,19	5,82	6,84	7,83	8,80	12,90	19,11	38,23
22	7/8"	40,46	7,16	8,13	8,60	10,15	14,34	21,02	39,20
25	1"	52,78	8,13	9,13	9,61	11,00	15,29	21,99	41,10
32	1 1/4"		12,61	11,47	12,81	13,51	18,16	25,81	46,85
38	1 1/2"			13,86	15,76	16,63	21,99	31,14	52,60
45	1 3/4"				22,70	24,86	32,49	39,50	68,84
50	2"				25,51	28,68	34,41	43,33	72,66
60	2 3/8"				29,30	45,92	51,62	63,09	123
70	2 3/4"					58,52	64,06	79,52	147
80	3 1/8"						97,82	110	160
90	3 1/2"						135	157	201
100	4"						149	172	241

Precios en € por 100 unidades. Medidas indicadas en m/m

## TORNILLO ROSCA CHAPA CABEZA AVELLANADA GOTA DE SEBO FORMA C

### SLOTTED RAISED COUNTERSUNK HEAD TAPPING SCREWS

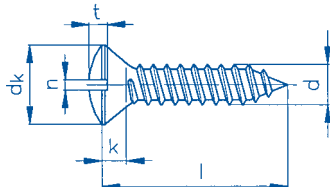

<b>t max.</b>	1,15	1,5	1,9	2,05	2,25	2,6	2,95	3,45
<b>n</b>	0,6	0,8	1	1	1,2	1,2	1,6	1,6
<b>k max.</b>	1,3	1,7	2,1	2,3	2,5	3	3,4	3,8
<b>dk max.</b>	4,3	5,5	6,8	7,5	8,1	9,5	10,8	12,4

<b>d</b>	<b>2,2</b>	<b>2,9</b>	<b>3,5</b>	<b>3,9</b>	<b>4,2</b>	<b>4,8</b>	<b>5,5</b>	<b>6,3</b>
<b>L n°</b>	<b>2</b>	<b>4</b>	<b>6</b>	<b>7</b>	<b>8</b>	<b>10</b>	<b>12</b>	<b>14</b>
<b>6,5</b> 1/4"	25,51	4,35	5,35	6,79	7,16			
<b>9,5</b> 3/8"	25,51	4,57	5,49	6,40	6,69	11,47		
<b>13</b> 1/2"	26,57	4,96	5,74	6,69	7,44	10,50	16,24	40,15
<b>16</b> 5/8"	30,08	5,30	6,21	7,44	7,93	11,47	17,21	40,15
<b>19</b> 3/4"	35,19	5,82	6,69	7,83	8,80	12,90	19,11	38,23
<b>22</b> 7/8"	40,46	7,16	8,13	8,60	10,15	14,34	21,02	39,20
<b>25</b> 1"	52,78	8,13	9,13	9,61	11,00	15,29	21,99	41,10
<b>32</b> 1 1/4"		12,61	11,47	12,81	13,51	18,16	25,81	46,85
<b>38</b> 1 1/2"			13,86	15,76	16,63	21,99	31,14	52,60
<b>45</b> 1 3/4"				22,70	24,86	32,49	39,50	68,84
<b>50</b> 2"				25,51	28,68	34,41	43,33	72,66
<b>60</b> 2 3/8"					45,92	51,62	63,09	123
<b>70</b> 2 3/4"					58,52	64,06	79,52	147
<b>80</b> 3 1/8"						97,82	110	160
<b>90</b> 3 1/2"						135	157	201
<b>100</b> 4"						149	172	241

Precios en € por 100 unidades. Medidas indicadas en m/m

## TORNILLO ROSCA CHAPA CABEZA EXAGONAL FORMA C HEXAGON HEAD TAPPING SCREWS

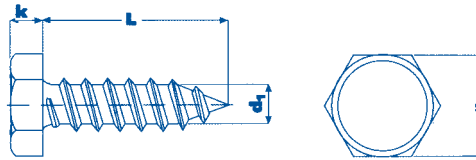

<b>k</b>	1,3	1,5	2,3	2,3	2,8	3	4	4,8	5,8
<b>s</b>	3,2	5	5,5	7	7	8	8	10	13

<b>d</b>	2,2	2,9	3,5	3,9	4,2	4,8	5,5	6,3	8
<b>nº</b>	2	4	6	7	8	10	12	14	16
<b>L 9,5</b>	22,87	21,99	27,27	32,20	34,31	45,74			
<b>13</b>	26,57	25,16	28,68	33,43	35,19	45,74	72,13	98,52	
<b>16</b>	27,45	26,74	29,73	34,13	36,95	49,26	72,13	104	206
<b>19</b>	31,67	29,73	33,25	35,19	40,46	51,02	77,41	107	206
<b>22</b>	36,95	38,71	40,46	45,74	51,02	58,06	87,97	114	213
<b>25</b>	42,22	42,22	43,98	49,26	52,78	61,58	96,76	127	234
<b>32</b>		52,78	54,54	58,06	61,58	73,89	107	137	264
<b>38</b>		58,06	58,06	68,61	68,61	82,69	120	160	297
<b>45</b>		73,89	68,61	73,89	84,45	106	135	172	340
<b>50</b>			84,45	77,41	98,52	123	150	183	355
<b>60</b>				87,97	123	150	179	227	389
<b>70</b>					137	176	206	248	435
<b>80</b>						206	227	274	
<b>90</b>						229	278	329	
<b>100</b>						297	341	412	
<b>110</b>						454	535	639	
<b>120</b>						540	644	762	

Precios en € por 100 unidades. Medidas indicadas en m/m

**ARANDELA GROWER PARA TORNILLOS CILÍNDRICOS**

SPRING LOCK WASHERS FOR SCREWS WITH CYLINDRICAL HEADS

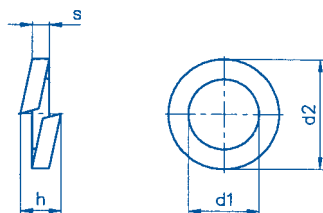

M	d <sub>1</sub> min.	d <sub>2</sub> max.	h min.	s	PRECIO
3	3,1	5,6	2	1	3,43
4	4,1	7	2,4	1,2	4,75
5	5,1	8,8	3,2	1,6	7,39
6	6,1	9,9	3,2	1,6	9,32
8	8,1	12,7	4	2	17,59
10	10,2	16	5	2,5	31,67
12	12,2	18	5	2,5	38,71
14	14,2	21,1	6	3	58,06
16	16,2	24,4	7	3,5	89,73
18	18,2	26,4	7	3,5	98,52
20	20,2	30,6	9	4,5	176
22	22,5	32,9	9	4,5	194
24	24,5	35,9	10	5	259
27	27,5	38,9	10	5	333
30	30,5	44,1	12	6	494

Precios en € por 100 unidades. Medidas indicadas en m/m

## TORNILLO ROSCA CHAPA CABEZA CILINDRICA FORMA C - PHILLIPS H CROSS RECESSED PAN HEAD TAPPING SCREWS PHILLIPS H

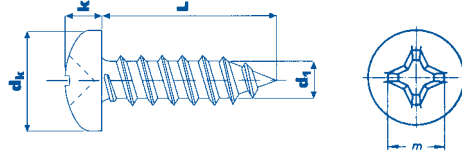

<b>dk</b>	4,2	5,6	6,9	7,5	8,2	9,5	10,8	12,5
<b>k max.</b>	1,8	2,2	2,6	2,8	3,05	3,55	3,95	4,55
<b>Nr. H</b>	1	1	2	2	2	2	3	3
<b>m</b>	2,6	3	4,2	4,4	4,7	5,1	6,8	7,1

<b>d1</b>	<b>2,2</b>	<b>2,9</b>	<b>3,5</b>	<b>3,9</b>	<b>4,2</b>	<b>4,8</b>	<b>5,5</b>	<b>6,3</b>
<b>L n°</b>	<b>2</b>	<b>4</b>	<b>6</b>	<b>7</b>	<b>8</b>	<b>10</b>	<b>12</b>	<b>14</b>
<b>6,5</b> 1/4"	25,33	3,73	5,07	6,60				
<b>9,5</b> 3/8"	23,05	4,01	5,26	6,21	6,60	8,80		
<b>13</b> 1/2"	23,05	4,29	5,54	6,69	7,16	10,03	14,34	32,49
<b>16</b> 5/8"	28,68	4,68	6,02	7,16	8,04	11,00	15,76	32,49
<b>19</b> 3/4"	29,73	5,07	6,69	7,64	8,97	12,42	17,21	33,46
<b>22</b> 7/8"	38,71	5,98	7,64	8,60	10,03	13,37	19,11	38,23
<b>25</b> 1"	49,26	7,16	8,60	9,55	11,00	14,53	20,88	40,15
<b>32</b> 1 1/4"		9,48	10,50	11,95	13,37	17,21	25,05	44,62
<b>38</b> 1 1/2"			13,37	15,29	16,24	20,07	28,89	50,67
<b>45</b> 1 3/4"			20,72	21,99	24,86	27,73	38,23	59,27
<b>50</b> 2"			23,58	24,28	26,76	29,63	43,02	62,14
<b>60</b> 2 3/8"			33,08	36,24	38,00	41,82	59,27	105
<b>70</b> 2 3/4"				45,39	49,09	49,97	73,61	135
<b>80</b> 3 1/8"					63,69	66,15	122	154
<b>90</b> 3 1/2"					77,60	92,72	142	190
<b>100</b> 4"						130	159	222
<b>120</b> 4 3/4"						181	225	255

Precios en € por 100 unidades. Medidas indicadas en m/m

## TORNILLO ROSCA CHAPA CABEZA AVELLANADA PLANA FORMA C - PHILLIPS H

CROSS RECESSED COUNTERSUNK HEAD TAPPING SCREWS PHILLIPS H

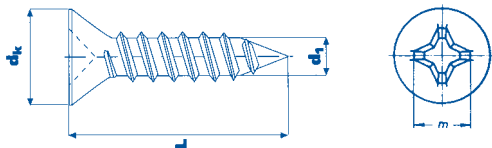

<b>d<sub>k</sub></b>	4,3	5,5	6,8	7,5	8,1	9,5	10,8	12,4
<b>k</b>	1,3	1,7	2,1	2,3	2,5	3	3,4	3,8
<b>Nr. H</b>	1	1	2	2	2	2	3	3
<b>m</b>	2,5	3	4,2	4,6	4,7	5,1	6,8	7,1

<b>d<sub>1</sub></b>	<b>2,2</b>	<b>2,9</b>	<b>3,5</b>	<b>3,9</b>	<b>4,2</b>	<b>4,8</b>	<b>5,5</b>	<b>6,3</b>
<b>L</b>	<b>2</b>	<b>4</b>	<b>6</b>	<b>7</b>	<b>8</b>	<b>10</b>	<b>12</b>	<b>14</b>
<b>6,5</b> 1/4"	25,33	3,73	5,07	6,60				
<b>9,5</b> 3/8"	23,05	4,01	5,26	6,21	6,60	8,80		
<b>13</b> 1/2"	23,05	4,29	5,54	6,69	7,16	10,03	14,34	32,49
<b>16</b> 5/8"	28,68	4,68	6,02	7,16	8,04	11,00	15,76	32,49
<b>19</b> 3/4"	29,73	5,07	6,69	7,64	8,97	12,23	17,21	33,46
<b>22</b> 7/8"	38,71	5,98	7,64	8,60	10,03	13,37	19,11	38,23
<b>25</b> 1"	49,26	7,16	8,60	9,55	11,00	14,53	20,88	40,15
<b>32</b> 1 1/4"		9,48	10,50	11,95	13,37	17,21	25,05	44,62
<b>38</b> 1 1/2"			13,37	15,29	16,24	20,07	28,89	50,67
<b>45</b> 1 3/4"			20,72	21,99	24,86	27,73	38,23	59,27
<b>50</b> 2"			23,58	24,28	26,76	29,63	43,02	62,14
<b>60</b> 2 3/8"			33,08	36,24	38,00	41,82	59,27	105
<b>70</b> 2 3/4"				45,39	49,09	49,97	73,61	135
<b>80</b> 3 1/8"					63,69	66,15	122	154
<b>90</b> 3 1/2"						92,72	142	190
<b>100</b> 4"						130	159	222

Precios en € por 100 unidades. Medidas indicadas en m/m

## TORNILLO PARA ROSCA CHAPA CABEZA AVELLANADA GOTA DE SEBO FORMA C - PHILLIPS H CROSS RECESSED RAISED COUNTERSUNK HEAD TAPPING SCREWS

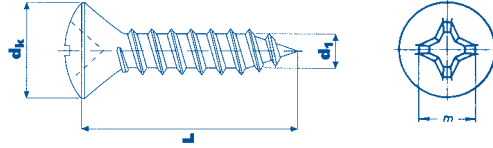

<b>d<sub>k</sub></b>	4,3	5,5	6,8	7,5	8,1	9,5	10,8	12,4
<b>K ≈</b>	1,3	1,7	2,1	2,3	2,5	3	3,4	3,8
<b>F</b>	0,7	0,9	1,2	1,3	1,4	1,5	1,7	2
<b>Nr. H</b>	1	1	2	2	2	2	3	3
<b>m</b>	2,8	3,4	4,6	4,7	4,9	5,4	7	7,4

<b>d<sub>1</sub></b>	<b>2,2</b>	<b>2,9</b>	<b>3,5</b>	<b>3,9</b>	<b>4,2</b>	<b>4,8</b>	<b>5,5</b>	<b>6,3</b>
<b>L n°</b>	<b>2</b>	<b>4</b>	<b>6</b>	<b>7</b>	<b>8</b>	<b>10</b>	<b>12</b>	<b>14</b>
<b>6,5</b> 1/4"	25,33	3,73	5,07	6,60				
<b>9,5</b> 3/8"	23,05	4,01	5,26	6,21	6,60	8,80		
<b>13</b> 1/2"	23,05	4,29	5,54	6,69	7,16	10,03	14,34	32,49
<b>16</b> 5/8"	28,68	4,68	6,02	7,16	8,04	11,00	15,76	32,49
<b>19</b> 3/4"	29,73	5,07	6,69	7,64	8,97	12,23	17,21	33,46
<b>22</b> 7/8"	38,71	5,98	7,64	8,60	10,03	13,37	19,11	38,23
<b>25</b> 1"	49,26	7,16	8,60	9,55	11,00	14,53	20,88	40,15
<b>32</b> 1 1/4"		9,48	10,50	11,95	13,37	17,21	25,05	44,62
<b>38</b> 1 1/2"			13,37	15,29	16,24	20,07	28,89	50,67
<b>45</b> 1 3/4"			20,72	21,99	24,86	27,73	38,23	59,27
<b>50</b> 2"			23,58	24,28	26,76	29,63	43,02	62,14
<b>60</b> 2 3/8"			33,08	36,24	38,00	41,82	59,27	105
<b>70</b> 2 3/4"				45,39	48,50	49,97	73,61	135
<b>80</b> 3 1/8"						66,15	122	154
<b>90</b> 3 1/2"						92,72	142	190
<b>100</b> 4"						130	159	222

Precios en € por 100 unidades. Medidas indicadas en m/m

## TORNILLO CILINDRICO CON EXAGONO INTERIOR CABEZA BAJA

### HEXAGON SOCKET HEAD CAP SCREWS WITH LOW HEAD

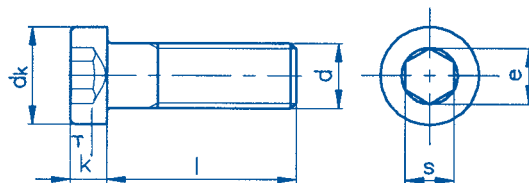

<b>e</b>	2,3	2,87	3,44	4,58	5,72	8,01	9,15	13,72	16
<b>t</b>	1,5	2,3	2,7	3	3,8	4,5	5	5,5	7,5
<b>s</b>	2	2,5	3	4	5	7	8	12	14
<b>k</b>	2	2,8	3,5	4	5	6	7	9	11
<b>dk</b>	5,5	7	8,5	10	13	16	18	24	30

<b>d</b>	<b>M-3</b>	<b>M-4</b>	<b>M-5</b>	<b>M-6</b>	<b>M-8</b>	<b>M-10</b>	<b>M-12</b>	<b>M-16</b>	<b>M-20</b>
<b>L 5</b>	151								
<b>6</b>	121	121							
<b>8</b>	89,73	89,73	139	186					
<b>10</b>	73,89	73,89	102	128	172				
<b>12</b>	73,89	73,89	102	128	172	500			
<b>16</b>	77,41	77,41	80,93	102	134	419	642		
<b>20</b>	82,69	82,69	86,21	111	150	359	577		
<b>25</b>	87,97	87,97	91,49	116	169	338	519	2.401	
<b>30</b>	100	100	107	127	178	369	528	2.315	
<b>35</b>		128	139	144	199	387	559	2.315	6.158
<b>40</b>		148	153	157	220	413	612	2.414	5.271
<b>45</b>			179	222	253	470	674	2.537	5.369
<b>50</b>			204	245	287	517	728	2.635	5.542
<b>60</b>			297	334	438	625	855	2.980	6.158
<b>70</b>			364	419	496	739	934	3.313	6.798
<b>80</b>					642	857	1.059	3.658	8.374

Precios en € por 100 unidades. Medidas indicadas en m/m



## TORNILLO CABEZA ALOMADA CON MORTAJA CRUZADA H-PHILLIPS CROSS RECESSED RAISED CHEESE HEAD SCREWS

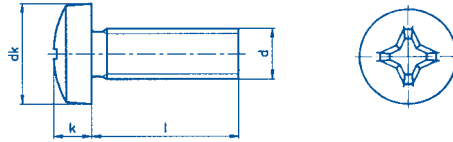

<b>d<sub>k</sub> max.</b>	3,2	4	5	6	8	10	12	16
<b>k</b>	1,3	1,6	2	2,4	3,1	3,8	4,6	6
<b>Nº H</b>	1	1	1	1	2	2	3	4

<b>d</b>	<b>M-1,6</b>	<b>M-2</b>	<b>M-2,5</b>	<b>M-3</b>	<b>M-4</b>	<b>M-5</b>	<b>M-6</b>	<b>M-8</b>
<b>L 4</b>	75,65	16,89	16,89	10,03				
<b>5</b>	75,65	12,49	12,49	10,03	15,31			
<b>6</b>	75,65	12,49	12,49	5,89	11,65	23,75		
<b>8</b>	77,41	12,67	12,67	5,98	9,89	19,04	29,56	
<b>10</b>	82,69	13,37	13,37	6,16	10,45	17,95	25,33	93,24
<b>12</b>	95,00	14,43	14,43	6,62	11,54	19,00	26,57	72,66
<b>14</b>		17,59	17,59	8,50	15,78	26,57	38,35	
<b>16</b>		15,66	15,66	7,14	13,20	21,11	29,73	79,35
<b>18</b>		23,75	23,75	10,93	16,40	32,58	44,86	
<b>20</b>		18,65	18,65	8,57	14,29	24,17	33,08	85,86
<b>22</b>				17,00	19,44	34,20	48,91	
<b>25</b>			20,24	12,67	16,50	27,48	36,28	93,60
<b>30</b>				14,29	19,88	31,84	41,78	102
<b>35</b>				23,49	24,19	36,59	46,18	125
<b>40</b>				26,92	27,48	40,64	51,69	132
<b>45</b>				50,18	50,84	58,50	58,27	153
<b>50</b>				52,08	53,48	60,17	62,63	159
<b>60</b>					84,45	97,12	100	188
<b>70</b>						136	148	225
<b>80</b>						179	188	273

Precios en € por 100 unidades. Medidas indicadas en m/m

## TORNILLO CABEZA AVELLANADA PLANA CON EXÁGONO INTERIOR HEXAGON SOCKET COUNTERSUNK HEAD SCREWS

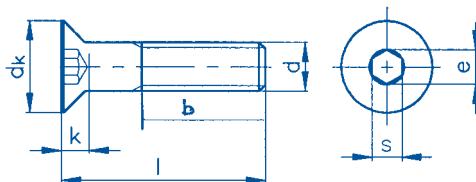

dk	6	8	10	12	16	20	24	30	36
e ≈	2,3	2,9	3,5	4,7	5,8	7	9,4	11,6	13,8
k	1,7	2,3	2,8	3,3	4,4	5,5	6,5	7,5	8,5
s	2	2,5	3	4	5	6	8	10	12
b L ≤ 125	12	14	16	18	22	26	30	38	46
b 125 < L ≤ 200				24	28	32	36	44	52

d	M-3	M-4	M-5	M-6	M-8	M-10	M-12	M-16	M-20
L 6	7,92	10,91	16,89						
8	8,09	9,94	13,72	20,06					
10	8,44	10,29	11,79	14,00	42,05				
12	8,88	10,73	11,79	14,00	27,66				
14	22,17	24,28	27,45	31,32	38,88				
16	9,59	11,08	12,49	14,78	28,71	87,09	294		
18	25,86	27,97	31,32	34,83	42,40	128			
20	11,00	11,72	14,20	17,51	33,37	53,84	144		
25	13,76	14,34	17,07	20,88	35,89	56,72	133		
30	16,71	18,12	19,90	24,45	41,17	64,04	138	786	2.255
35		21,55	24,98	27,89	46,80	73,01	156	822	2.270
40	20,76	24,81	28,50	34,66	52,08	81,98	166	1.010	2.555
45		35,01	37,83	43,81	62,81	91,34	181	1.064	2.641
50		35,01	41,52	46,97	69,85	102	192	1.131	2.804
55			75,30	57,88	84,62	119	225	1.298	2.957
60		76,00	62,28	59,47	89,55	130	246	1.346	3.021
65				97,99	123	165	303	1.809	3.439
70			119	97,99	123	165	313	1.809	3.439
80				112	159	204	378	1.976	3.719
90				146	231	294	507	2.472	5.195
100				190	310	376	662	2.966	6.766
110					403	508	864	3.855	8.119
120					523	603	998	4.485	9.407
130								5.829	11.758
140								7.579	14.697

Precios en € por 100 unidades. Medidas indicadas en m/m

**TORNILLO ROSCA MADERA CABEZA PLANA  
MORTAJA CRUZADA Z-POZIDRIVE**  
CROSS RECESSED COUNTERSUNK HEAD WOOD SCREWS POZIDRIVE-Z

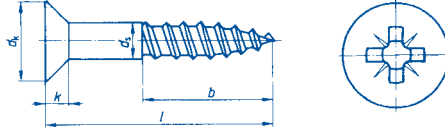

<b>dk</b>	5,6	6,5	7,5	8,3	9,2	11
<b>k</b>	1,65	1,93	2,2	2,35	2,5	3
	$b \geq a 0,6 L$					

<b>ds</b>	<b>3</b>	<b>3,5</b>	<b>4</b>	<b>4,5</b>	<b>5</b>	<b>6</b>
<b>L 12</b>	95,00	98,52	123			
<b>16</b>	73,89	77,41	91,49	158	176	
<b>20</b>	80,93	80,93	102	137	150	
<b>25</b>	87,97	86,21	118	143	165	450
<b>30</b>	96,76	102	132	160	179	464
<b>35</b>	118	114	144	176	209	503
<b>40</b>			158	204	215	515
<b>45</b>			190	215	225	537
<b>50</b>			218	232	255	568
<b>60</b>				303	271	635
<b>65</b>					311	732
<b>70</b>					359	841
<b>80</b>					429	983
<b>90</b>					515	1.181
<b>100</b>					618	1.416

Precios en € por 100 unidades. Medidas indicadas en m/m



## ARANDELA PLANA

## DIÁMETRO EXTERIOR= 3X DIAMETRO NOMINAL DE ROSCA

## WASHERS WITH OUTSIDE DIAMETER= 3X NOMINAL THREAD DIAMETER

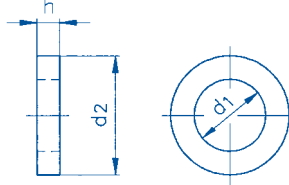

M	d <sub>1</sub>	d <sub>2</sub> max.	h	PRECIO
2	2,2	7	0,8	9,85
2,5	2,7	8	0,8	9,85
3	3,2	9	0,8	1,67
3,5	3,7	11	0,8	5,63
4	4,3	12	1	2,52
5	5,3	15	1,2	4,19
6	6,4	18	1,6	5,91
7	7,4	22	2	33,08
8	8,4	24	2	13,99
10	10,5	30	2,5	25,69
12	13	37	3	55,95
14	15	44	3	82,16
16	17	50	3	99,23
18	19	56	4	197
20	22	60	4	247
22	22	60	4	247
24	25	72	5	508

Precios en € por 100 unidades. Medidas indicadas en m/m

## ARANDELA CONTACTO SERIE M

CONTACT WASHERS, TYPE M

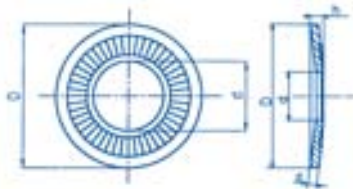

M	d	D	h max.	h min.	s	PRECIO
3	3,2	8	1	0,80	0,6	20
4	4,3	10	1,40	1,15	0,90	21
5	5,3	12	1,80	1,45	1,10	25
6	6,4	14	2,10	1,75	1,30	36
8	8,4	18	2,35	1,90	1,40	55
10	10,5	22	2,75	2,25	1,60	88
12	12,5	27	3,10	2,60	1,80	151
14	14,5	30	3,70	3,20	2,40	263
16	16,5	32	4,10	3,60	2,80	324
20	21	40	4,90	4,30	3,20	518

Precios en € por 100 unidades. Medidas indicadas en m/m

## TORNILLO SOLDABLE WELDING BOLTS

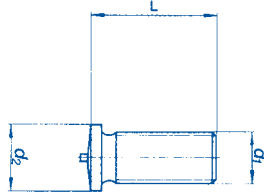

d <sub>2</sub>	4,5	5,5	6,5	7,5	9

d <sub>1</sub>	M-3	M-4	M-5	M-6	M-8
L 8		62,10	75,30	97,64	
10	53,84	66,50	83,57	99,40	273
15	75,48	94,83	103	125	285
20	89,37	117	143	165	355
25	103	143	171	209	387
30		162	194	241	431
35		190	230	303	526
40			253	380	584
45					616
50					672

Precios en € por 100 unidades. Medidas indicadas en m/m

**POELIERS**  
**TORNILLO CABEZA ABOMBADA RANURADA**  
SLOTTED SCREW MUSHROOM HEAD

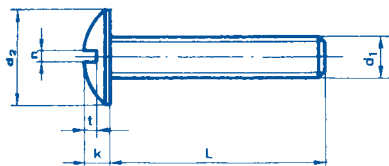

<b>d<sub>2</sub></b>	6,9	10	12,5	15	20
<b>k</b>	2	2,2	2,7	3,3	4,4
<b>n</b>	0,8	1,2	1,2	1,6	2
<b>t</b>	0,95	1,0	1,2	1,5	2

<b>d</b>	<b>M-3</b>	<b>M-4</b>	<b>M-5</b>	<b>M-6</b>	<b>M-8</b>
<b>L 10</b>	25,16	36,77	61,58	86,21	
<b>12</b>	27,09	37,83	63,34	96,76	303
<b>16</b>	32,90	42,58	73,89	113	262
<b>20</b>	36,77	46,45	80,93	127	280
<b>25</b>	46,45	52,25	95,00	134	290
<b>30</b>	65,80	73,54	109	162	333
<b>35</b>	105	83,22	143	185	357
<b>40</b>	112	90,96	157	201	382
<b>45</b>	120	114	172	229	442
<b>50</b>	126	126	188	239	472
<b>60</b>		216	229	304	561
<b>70</b>			283	350	684
<b>80</b>			355	380	739
<b>90</b>				505	943
<b>100</b>				574	1.003

Precios en € por 100 unidades. Medidas indicadas en m/m









**ENGRASADORES HIDRÁULICOS (ACODADO 90°)**

LUBRICATING NIPPLES; CONE TYPE

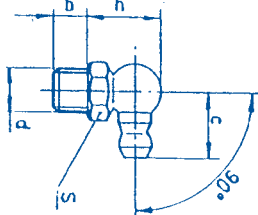

Ref.	Rosca	s	b	h	c	PRECIO
10011	M6 x 1	11	7	15	16	3.491
10011	M8 x 1	11	7	15	16	3.589
10011	M8 x 1,25	11	7	15	16	3.589
10011	M10 x 1	11	7	15	16	4.335
10011	M10 x 1,25	11	7	15	16	4.335
10011	M10 x 1,50	11	7	15	16	4.335
10011 G	GAS 1/8"	11	7	15	16	4.434
10011 G	GAS 1/4"	14	8,5	16	16	7.192

Precios en € por 100 unidades. Medidas indicadas en m/m

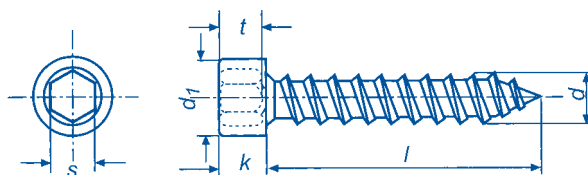
**TORNILLO CABEZA DIN-912 ROSCA CHAPA**  
TAPPING SCREWS WITH HEAD DIN-912

<b>s</b>	4	5	5
<b>d<sub>1</sub></b>	8,5	10	10
<b>k max.</b>	5	6	6
<b>t min.</b>	2,5	3	3

<b>d</b>	<b>4,8</b>	<b>5,5</b>	<b>6,3</b>
<b>L</b> 13	89,73	95	
16	93,24	100	120
19	98,52	104	125
22	104	109	132
25	109	116	141
32	116	123	148
38	127	134	162
45	143	151	181
50	148	158	190
60	164	178	213
70	179	208	250

Precios en € por 100 unidades. Medidas indicadas en m/m



## ARANDELA CÓNICA 90° DECOLLETADA "OVALILLO" NFE 27619 ROSETTE TURNED FULL BODY, 90°

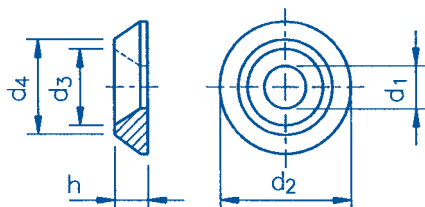

### HX10018\*

Para tornillo	d <sub>1</sub> min.	d <sub>2</sub> max.	d <sub>3</sub> min.	h min.	d <sub>4</sub>	PRECIO
M-3	3,2	10	6,5	1,8	7,3	104
M-4	4,3	14	8,6	2,3	9,5	130
M-5	5,3	16	10,4	2,8	11,5	179
M-6	6,4	18	12,4	3,3	13,5	248
M-8	8,4	25	16,4	4,8	17,5	517
M-10	10,5	31	20,4	5,5	21,5	978

\* Calidad AISI 303-A1

## ARANDELA CÓNICA 90° EMBUTIDA "OVALILLO" NFE 27619 ROSETTE - OPEN MODEL-

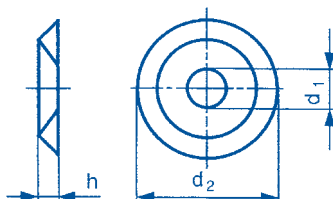

### HX10019

Para tornillo	d <sub>2</sub>	d <sub>1</sub>	h	PRECIO
M-3	9	3,2	1,9	42,22
M-4	13	4,8	2,7	65,10
M-5	15	5,5	3,2	89,73
M-6	17	6,6	3,2	125

Precios en € por 100 unidades. Medidas indicadas en m/m

### ARMELLAS-HEMRILLAS CERRADAS ROSCA MÉTRICA SCREW EYES

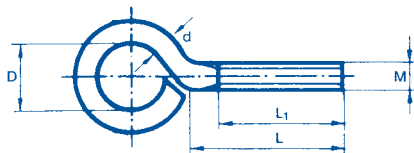

M	L	D	L <sub>1</sub>	d	PRECIO
5	30	8	27	4,4	378
5	40	8	37	4,4	454
5	50	8	47	4,4	533
6	20	10	18	5,25	477
6	30	10	27	5,25	493
6	40	10	37	5,25	558
6	60	10	57	5,25	691
8	60	10	57	7	1.056
8	80	10	77	7	1.207
10	70	15	65	8,85	1.847

Precios en € por 100 unidades. Medidas indicadas en m/m

## ARANDELAS DE ESTANQUEIDAD EPDM-NEOPRENO SEALING WASHERS

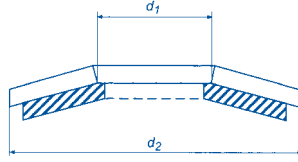

d <sub>1</sub>	d <sub>2</sub>	PRECIO
4,7	12	24,81
5,2	12	25,51
5,2	14	30,96
5,2	16	36,59
6,7	14	32,55
6,7	16	38,18
6,7	18	46,45
6,7	19	56,12
6,7	22	75,30
6,7	25	97,29
6,7	29	126
7,5	16	41,87
8,5	16	41,87
8,5	17	43,46
8,5	19	55,95
8,5	22	75,48
8,5	25	97,29
8,5	29	126
9,2	19	56,12
9,2	22	75,30
10,5	25	97,29
10,5	29	126
13	29	126

Precios en € por 100 unidades. Medidas indicadas en m/m

**TORNILLO ROSCA CHAPA CABEZA PLANA**  
SELF TAPPING SCREWS EXTRA LOW

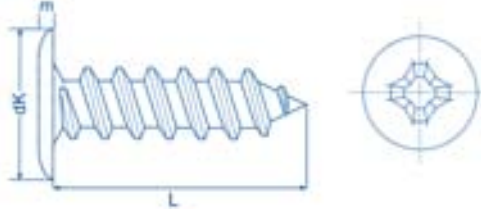

<b>dK</b>	7,0	8,10
<b>m</b>	1,1	1,1

<b>d</b>	<b>3,9</b>	<b>4,2</b>
<b>L 9,5</b>	12,70	12,70
<b>13</b>		13,90

Precios en € por 100 unidades. Medidas indicadas en m/m



**TORNILLO DE SEGURIDAD CABEZA  
SIMILAR ISO 7380 Y 7991 TORX + TETON**  
SECURITY - HEXAGON SOCKET SCREWS PIN - TORX

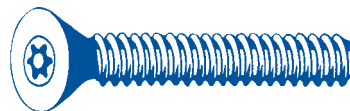
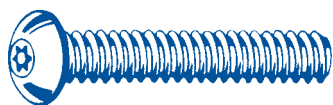

Ø	M-3	M-4	M-5	M-6	M-8	M-10
L 6	75,65	77,41				
8	77,41	79,17				
10	79,17	82,69	91,49	111	151	
12	82,69	86,21	95,00	114	155	
16	86,21	89,73	100	120	160	296
20	89,73	93,24	107	127	167	301
25		98,52	113	135	178	310
30		107	118	143	202	334
40		113	127	157	241	385
50					294	473
60					313	524

Precios en € por 100 unidades. Medidas indicadas en m/m



## ANILLOS DE SUJECION PARA EJES FIXING WASHERS FOR SHAFTS (WITHOUT CAP)

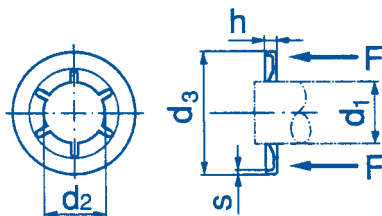

### HX10028

Ø nominal d1 (h11)	d2 max.	d3	h	s	PRECIO
3	2,81	9,7	1,3	0,2	150
4	3,8	11,5	1,3	0,2	150
5	4,74	11,5	1,3	0,2	194
6	5,7	15,3	1,3	0,25	253
8	7,66	15,3	1,3	0,25	329
10	9,74	18,4	1,9	0,3	431
12	11,62	25	1,9	0,4	556

## ANILLOS DE SUJECION PARA EJES CON SOMBRETE FIXING WASHERS FOR SHAFTS (WITH CAP TYPE A)

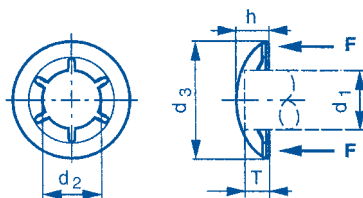

### HX10042

Ø nominal d1 (h11)	d2 max.	d3	h	s	PRECIO
3	2,81	10,6	3	2,54	225
4	3,8	12,4	3,8	3,05	225
5	4,74	12,4	3,8	3,05	290
6	5,7	16,2	5	4,06	380
8	7,66	16,2	5	4,06	493
10	9,74	19,7	6	4,5	646
12	11,62	26	7,5	6	834

Precios en € por 100 unidades. Medidas indicadas en m/m



## TUERCAS DE SEGURIDAD INVOLABLES SECURITY -INVOLABLE NUTS-

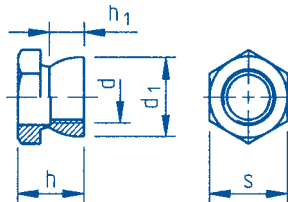

d	d <sub>1</sub> ≈	h	h <sub>1</sub> ≈	s	Rotura Nm	PRECIO
M-6	9,3	9,5	4,3	10	10-18	208
M-8	12,5	12	7	13	13-21	252
M-10	16,3	15	8,3	17	31-38	690
M-12	18,3	16	8,3	19	40-45	908
M-16	23,3	22	12,3	24	55-60	1.666

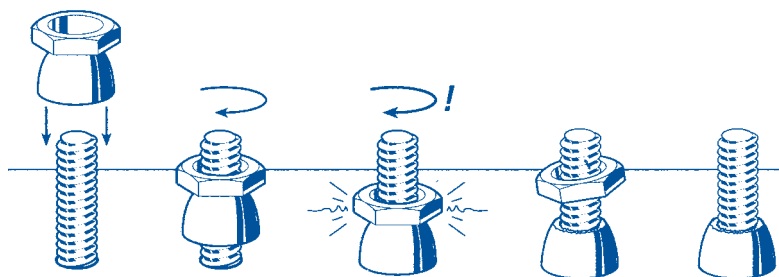

**TORNILLO DE SEGURIDAD "ONE WAY" ROSCA CHAPA**  
SECURITY -ONE WAY- TAPPING SCREWS

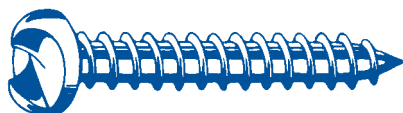

**HX10032**

Ø	2,9	3,5	4,2	4,8	5,5	6,3
<b>L 9,5</b>	46,62					
<b>13</b>	51,90	56,30	61,58	79,17	86,21	137
<b>19</b>	54,54	61,58	66,85	86,21	95,00	146
<b>25</b>		66,85	72,13	93,24	102	157
<b>32</b>		73,89	79,17	100	111	167
<b>38</b>			87,97	107	130	179
<b>50</b>				116	169	201
<b>63</b>					236	227

**TORNILLO DE SEGURIDAD "ONE WAY" ROSCA METRICA**  
SECURITY -ONE WAY- SCREWS

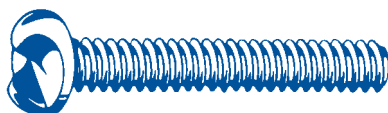

**HX10033**

M	4	5	6	8
<b>L 8</b>	65,10	73,89		
<b>10</b>	65,10	73,89	95	141
<b>12</b>	68,61	77,41	100	144
<b>16</b>	72,13	82,69	109	153
<b>20</b>	75,65	87,97	118	160
<b>25</b>	82,69	96,76	125	172
<b>30</b>	95	109	134	197
<b>35</b>	104	130	155	220
<b>40</b>	116	151	174	243
<b>50</b>	139	172	208	269
<b>60</b>		194	232	313
<b>70</b>		227	287	345

Precios en € por 100 unidades. Medidas indicadas en m/m



**TORNILLO DE SEGURIDAD CABEZA SIMILAR ISO 7380 Y 7991 CON EXAGONO INTERIOR + TETON**  
SECURITY - HEXAGON SOCKET SCREWS PIN - HEXAGON

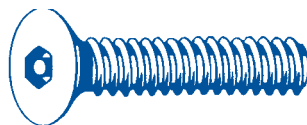
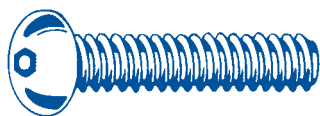

Ø	M-3	M-4	M-5	M-6	M-8	M-10
<b>L 6</b>	75,65	77,41				
<b>8</b>	77,41	79,17				
<b>10</b>	79,17	82,69	91,49	111	151	
<b>12</b>	82,69	86,21	95,00	114	155	
<b>16</b>	86,21	89,73	100	120	160	296
<b>20</b>	89,73	93,24	107	127	167	301
<b>25</b>		98,52	113	135	178	310
<b>30</b>		107	118	143	202	334
<b>40</b>		113	127	157	241	385
<b>50</b>					294	473
<b>60</b>					313	524

Precios en € por 100 unidades. Medidas indicadas en m/m

HX10036 (7380)

HX10037 (7991)

ACERO INOXIDABLE - STAINLESS STEEL

A2  
aisi 304

**TORNILLO DE SEGURIDAD ROSCA CHAPA CABEZA  
SIMILAR ISO 7380 Y 7991 CON EXAGONO INTERIOR  
+ TETON**

SECURITY -HEXAGON SOCKET TAPPING SCREWS PIN - HEXAGON

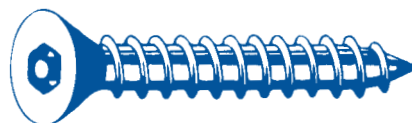
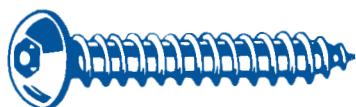

Ø	3,5	4,2	4,8	5,5	6,3
L 9,5	125				
13	125	128	137	157	
16	128	132	143	165	179
19	134	137	148	172	186
25	141	144	153	181	195
32	148	151	162	192	206
38	155	160	171	204	218
50		169	181	218	234

Precios en € por 100 unidades. Medidas indicadas en m/m



Hispanox s.a.

Tel. 93 729 99 60 - Fax 93 729 99 61

**TORNILLO DE SEGURIDAD CABEZA SIMILAR DIN 85 Y 963  
CON 2 AGUJEROS**  
SECURITY - SCREWS WITH 2 HOLES

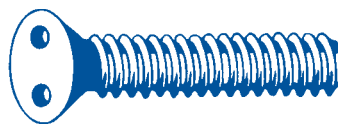
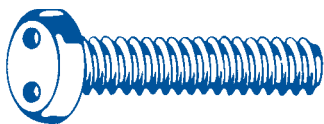

Ø	M-3	M-4	M-5	M-6
L 6	140	153		
8	140	153		
10	143	157	167	
12	143	157	167	202
16	146	160	171	202
20		164	174	220
25		167	178	229
30			183	238
40				278

Precios en € por 100 unidades. Medidas indicadas en m/m

HX10040 (7971)

HX10041 (7972)

ACERO INOXIDABLE - STAINLESS STEEL

A2  
aisi 304

**TORNILLO DE SEGURIDAD ROSCA CHAPA CABEZA  
SIMILAR DIN 7971 Y 7972 CON 2 AGUJEROS**

SECURITY -TAPPING SCREWS WITH 2 HOLES

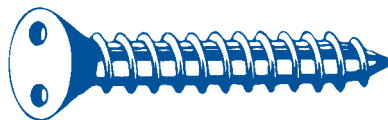
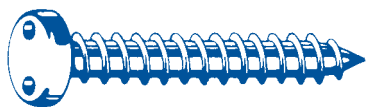

$\varnothing$	2,9	3,5	4,2	4,8	5,5	6,3
L 6,5	113					
9,5	113	116	123	134		
13	113	116	123	134	179	208
16	118	121	128	139	179	208
19	121	127	134	146	190	218
25	128	132	139	153	199	229
32		137	146	160	209	250
38		143	153	169	218	269
45		171	185	197	241	289
50		179	201	223	255	310

Precios en € por 100 unidades. Medidas indicadas en m/m



Hispanox s.a.

Tel. 93 729 99 60 - Fax 93 729 99 61

## TUERCAS DE CONEXION CILINDRICA ROUND COUPLER NUTS

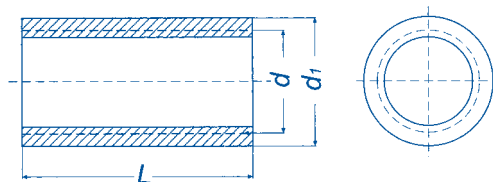

### HX10043

$d_1$	10	11	13	15	22	28
$d$	M-6	M-8	M-10	M-12	M-16	M-20
L 20	623	813				
25	741	871	1.277			
30	876	1.077	1.524	2.041		
35		1.172	1.749	2.264		
40		1.330	1.819	2.343	4.117	
50		1.666		2.628	5.109	8.813

## TUERCAS DE CONEXION EXAGONALES HEXAGON COUPLER NUTS

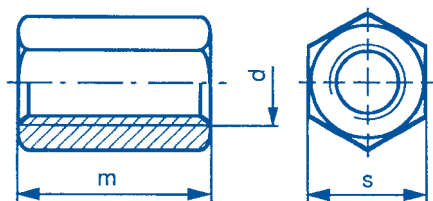

### HX10044

S	10	13	17	19	24	30	36
$d$	M-6	M-8	M-10	M-12	M-16	M-20	M-24
m 25	823	1.415	2.428				
30	994	1.684	2.924	3.452			
40			3.897	4.117	4.624		
50				5.130	6.122	10.345	
60							15.394

Precios en € por 100 unidades. Medidas indicadas en m/m



## TUERCAS PARA SOLDAR WELD-ON NUT



M	d <sub>1</sub>	b	h	d	PRECIO
4	4,9	9	6	17	150
5	6,1	11	7,5	19	160
6	7	11	7,5	22	172
6	7,5	14	8,5	22	206
8	9	14	8,5	26	218
8	9,7	18	9,7	26	274
10	11,5	18	11,5	26	297

Precios en € por 100 unidades. Medidas indicadas en m/m

## PASADOR TIPO BETA SIMPLE PINS TYPE "BETA"

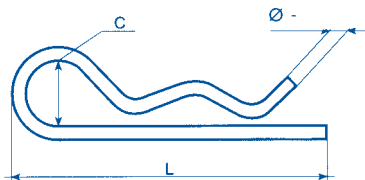

$\beta$	C	L	PRECIO
2	11	47	72,13
2,5	16	64	127
3	22	68	179
3,5	22	74	329
4	21	86	392
4,5	23	90	591
5	24	97	649
6	25	108	980
7	26	123	1.564

Precios en € por 100 unidades. Medidas indicadas en m/m

## TORNILLO CABEZA CILINDRICA SLOTTED CHEESE HEAD SCREWS

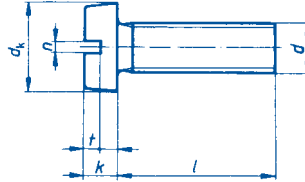

t min.	0,45	0,6	0,7	0,85	1	1,1	1,3	1,6	2	2,4
n	0,4	0,5	0,6	0,8	1	1,2	1,2	1,6	2	2,5
k	1	1,3	1,6	2	2,4	2,6	3,3	3,9	5	6
dk	3	3,8	4,5	5,5	6	7	8,5	10	13	16

d	M-1,6	M-2	M-2,5	M-3	M-3,5	M-4	M-5	M-6	M-8	M-10
L 3		22,98	22,98							
4	70,38	22,98	22,98	20,08						
5	68,31	24,63	24,63	18,22	93,15	25,67				
6	64,17	25,88	25,88	13,25	95,22	17,66	31,88			
8	68,31	28,36	28,36	12,38	93,15	16,81	23,39	33,33		
10	70,38	31,26	31,26	11,16	93,15	15,65	22,15	30,64	140	
12	80,73	35,40	35,40	12,21	93,15	16,27	24,43	32,71	123	
14	118	47,61	47,61	16,97		23,18	34,36	44,92		
16	97,29	41,40	41,40	13,31	108	17,80	26,50	35,50	131	484
18		60,03	60,03	18,84		25,88	38,09	50,51		
20		49,68	49,68	15,21	114	19,87	29,39	39,43	138	371
22		104	104	26,50		29,81	44,09	55,48		
25		51,75	51,75	21,11	159	22,94	33,95	44,09	145	395
30		116	116	24,43	190	27,12	38,30	50,72	162	457
35				42,50	195	40,57	56,93	66,45	228	501
40				57,40	250	47,40	65,00	84,04	242	542
45						79,90	85,49	106	273	635
50						93,56	97,70	123	308	654
60						117	120	149	335	725
70							185	226	530	905
80							211	255	662	1.130
90								331	791	1.414
100								431	818	1.768

Precios en € por 100 unidades. Medidas indicadas en m/m

## TORNILLO CABEZA ALOMADA SLOTTED PAN HEAD SCREWS

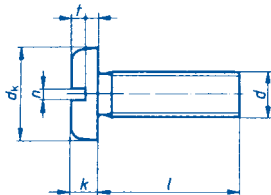

t min.	0,6	0,7	0,8	1	1,2	1,4	1,9
n	0,5	0,6	0,8	1,2	1,2	1,6	2
k	1,3	1,5	1,8	2,4	3	3,6	4,8
dk	4	5	6	8	10	12	16

d	M-2	M-2,5	M-3	M-4	M-5	M-6	M-8
L 3	72,45	72,45					
4	64,17	64,17	29,60				
5	30,22	30,22	24,43	28,36			
6	31,26	31,26	14,70	19,87	34,36		
8	33,12	33,12	14,08	18,84	26,50	46,16	
10	35,40	35,40	12,63	17,80	24,63	30,02	194
12	39,74	39,74	13,87	18,42	27,74	32,71	179
16	43,47	43,47	14,90	20,08	29,81	35,40	160
20	49,68	49,68	17,18	22,15	32,91	39,74	175
25		72,45	22,15	25,88	38,09	44,92	190
30			27,53	30,64	42,44	50,30	206
35			49,68	44,92	63,76	74,73	271
40			60,03	52,99	73,28	95,01	294
45				89,42	95,01	118	335
50				107	110	138	371
60				115	118	167	402
70					191	230	551
80					238	286	658
90					357	387	950
100					442	468	1.006

Precios en € por 100 unidades. Medidas indicadas en m/m



### PASADOR ALETA COTTER PINS

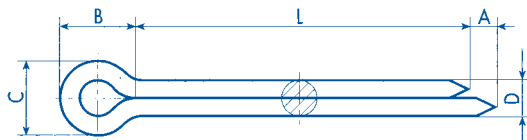

<b>D min.</b>	0,8	1	1,3	1,7	2,1	2,7	3,5	4,4	5,7	7,3	9,3
<b>D max.</b>	0,9	1,1	1,4	1,8	2,3	2,9	3,7	4,6	5,9	7,5	9,5
<b>B</b>	3	3	3,2	4	5	6,4	8	10	12,6	16	20
<b>c max.</b>	1,8	2	2,8	3,6	4,6	5,8	7,4	9,2	11,8	15	19
<b>A max.</b>	1,6	2,5	2,5	2,5	2,5	3,2	4	4	4	4	6,3

d*	1	1,2	1,6	2	2,5	3,2	4	5	6,3	8	10
<b>L 8</b>	8,07	8,07	8,07	15,94							
<b>10</b>	9,52	9,52	9,52	17,18	22,98						
<b>12</b>	10,76	10,76	10,76	20,29	26,91						
<b>16</b>	13,87	13,87	15,11	21,53	31,05	43,47	78,66	122			
<b>18</b>	15,53	15,53	16,15	24,22	34,98	51,75	80,73	135			
<b>20</b>	18,42	18,42	20,29	26,50	39,12	53,82	86,94	139	203		
<b>22</b>	20,29	20,29	21,53	28,36	43,47	55,89	91,08	143	215		
<b>25</b>	21,74	21,74	23,18	30,22	49,68	60,03	99,36	153	234		
<b>28</b>	22,98	22,98	25,46	34,98	53,82	64,17	104	161	250		
<b>32</b>	24,22	24,22	26,91	39,12	57,96	68,31	114	184	261	511	807
<b>36</b>	43,47	43,47	29,60	43,47	64,17	76,59	130	203	288	565	888
<b>40</b>	51,75	51,75	33,74	51,75	68,31	84,87	143	224	315	619	923
<b>45</b>	60,03	60,03	60,03	64,17	72,45	86,94	157	242	342	673	996
<b>50</b>						106	168	261	377	706	1.076
<b>56</b>						114	184	284	404	753	1.157
<b>63</b>						168	195	296	431	807	1.252
<b>71</b>							230	337	484	888	1.399
<b>80</b>							242	381	538	915	1.480
<b>90</b>							277	457	592	969	1.615
<b>100</b>							327	499	673	1.103	1.749

Precios en € por 100 unidades. Medidas indicadas en m/m

## TORNILLO ROSCA MADERA CABEZA GOTA DE SEBO SLOTTED RAISED COUNTERSUNK HEAD WOOD SCREW

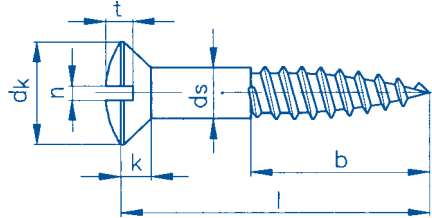

$b \geq 0,6 L$

<b>t<sub>max.</sub></b>	1,2	1,45	1,7	1,9	2,1	2,3	2,8	3,7
<b>n</b>	0,6	0,8	0,8	1	1	1,2	1,6	2
<b>f<sub>≈</sub></b>	0,6	0,75	0,9	1	1,1	1,25	1,5	2
<b>k</b>	1,5	1,65	1,93	2,2	2,35	2,5	3	4
<b>d<sub>k</sub></b>	4,7	5,6	6,5	7,5	8,3	9,2	11	14,5

<b>n°</b>	17	18	19	20	21	22	24	27
<b>d<sub>s</sub></b>	2,5	3	3,5	4	4,5	5	6	8
<b>L 10</b>	34,57							
<b>12</b>	34,57	34,57	36,02					
<b>16</b>	32,09	32,09	33,33	40,57	56,51	66,03		
<b>20</b>	33,33	33,33	35,40	40,99	57,13	66,03	100	
<b>25</b>	37,67	37,67	40,99	45,75	61,69	70,79	100	
<b>30</b>	50,30	50,30	52,99	57,13	66,03	75,35	112	619
<b>35</b>		54,86	59,41	61,69	70,79	82,39	121	619
<b>40</b>		62,10	66,03	70,79	82,39	86,73	132	652
<b>45</b>			80,73	84,46	91,49	100	150	714
<b>50</b>			90,05	93,56	99,98	114	167	753
<b>60</b>				149	171	180	209	888
<b>65</b>						244	238	
<b>70</b>					228	250	282	1.023
<b>80</b>						366	435	1.157
<b>90</b>							702	1.319
<b>100</b>							890	1.459
<b>110</b>								
<b>120</b>								

\* diametro nominal del agujero pasante.

Precios en € por 100 unidades. Medidas indicadas en m/m



### TORNILLO ROSCA MADERA CABEZA REDONDA SLOTTED ROUND HEAD WOOD SCREWS

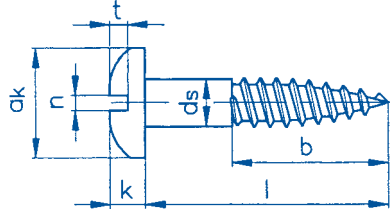

$b \geq 0,6 L$

<b>t max.</b>	1,1	1,35	1,6	1,8	2	2,3	2,7	3,6
<b>n</b>	0,6	0,8	0,8	1	1	1,2	1,6	2
<b>K</b>	1,7	2,1	2,4	2,8	3,1	3,5	4,2	5,6
<b>dk</b>	5	6	7	8	9	10	12	16

<b>n°</b>	17	18	19	20	21	22	24	27
<b>ds</b>	2,5	3	3,5	4	4,5	5	6	8
<b>L 10</b>	34,57							
<b>12</b>	34,57	34,57	36,02					
<b>16</b>	32,09	32,09	33,33	40,57	56,51	66,03		
<b>20</b>	33,33	33,33	35,40	40,99	57,13	66,03	100	
<b>25</b>	37,67	37,67	40,99	45,75	61,69	70,79	100	
<b>30</b>	50,30	50,30	52,99	57,13	66,03	75,35	112	619
<b>35</b>		54,86	59,41	61,69	70,79	82,39	121	619
<b>40</b>		62,10	66,03	70,79	82,39	86,73	132	652
<b>45</b>			80,73	84,46	91,49	100	150	714
<b>50</b>			90,05	93,56	99,98	114	167	753
<b>60</b>				149	171	180	209	888
<b>65</b>						244	238	
<b>70</b>					228	250	282	1.023
<b>80</b>						366	435	1.157
<b>90</b>							702	1.319
<b>100</b>							890	1.459
<b>110</b>								
<b>120</b>								

Precios en € por 100 unidades. Medidas indicadas en m/m



## TORNILLO ROSCA MADERA CABEZA PLANA SLOTTED COUNTERSUNK HEAD WOOD SCREWS

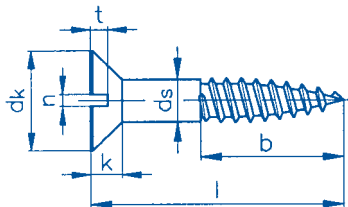

$b \geq 0,6 L$

<b>t max.</b>	0,7	0,85	1	1,1	1,2	1,3	1,6	2,1
<b>n</b>	0,6	0,8	0,8	1	1	1,2	1,6	2
<b>K</b>	1,5	1,65	1,93	2,2	2,35	2,5	3	4
<b>dk</b>	4,7	5,6	6,5	7,5	8,3	9,2	11	14,5

<b>n°</b>	17	18	19	20	21	22	24	27
<b>ds</b>	2,5	3	3,5	4	4,5	5	6	8
<b>L 10</b>	31,26	31,26						
<b>12</b>	31,26	31,26	32,50					
<b>16</b>	28,77	28,77	30,02	41,19	50,92	59,41		
<b>20</b>	30,02	30,02	31,88	36,85	51,54	59,41	90,46	
<b>25</b>	37,05	37,05	36,85	41,19	55,48	63,76	90,46	
<b>30</b>	45,33	45,33	47,82	51,34	59,41	74,73	101	619
<b>35</b>		49,47	53,41	57,55	66,65	81,35	117	619
<b>40</b>		55,89	59,41	63,76	74,31	86,11	127	652
<b>45</b>			72,66	75,97	82,39	100	145	714
<b>50</b>			81,14	84,25	90,05	113	161	753
<b>60</b>				134	154	162	202	888
<b>65</b>						219	215	
<b>70</b>					205	226	255	1.023
<b>80</b>						329	391	1.023
<b>90</b>							633	1.091
<b>100</b>							801	1.157
<b>110</b>								
<b>120</b>								

Precios en € por 100 unidades. Medidas indicadas en m/m



### ARANDELA PLANA WASHERS

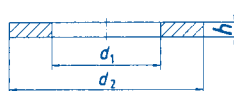
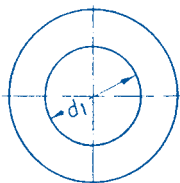

M	d <sub>1</sub>	d <sub>2</sub>	h	PRECIO
1,6	1,7	4	0,3	25,67
2	2,2	5	0,3	6,90
2,5	2,7	6,5	0,5	6,90
3	3,2	7	0,5	2,28
3,5	3,7	8	0,5	7,66
4	4,3	9	0,8	2,59
5	5,3	10	1	3,11
6	6,4	12	1,6	5,44
7	7,4	14	1,6	15,73
8	8,4	16	1,6	8,59
10	10,5	20	2	17,39
12	13	24	2,5	29,39
14	15	28	2,5	49,06
16	17	30	3	56,72
18	19	34	3	79,90
20	21	37	3	90,87
22	23	39	3	142
24	25	44	4	202
27	28	50	4	304
30	31	56	4	410
33	34	60	5	1.598
36	37	66	5	2.039
39	40	72	6	2.563
42	43	78	7	3.033
45	46	85	7	5.446
48	50	92	8	6.974

Precios en € por 100 unidades. Medidas indicadas en m/m



## ARANDELA DE MUELLE ABOMBADA FORMA A SPRING WASHERS, HEAVY DUTY

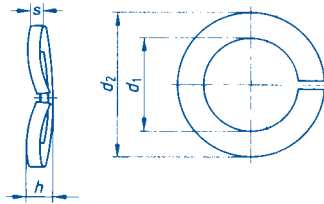

M	d <sub>1</sub>	d <sub>2</sub>	s	h min.	h max.	PRECIO
2	2,1	4,4	0,5	0,7	0,9	14,28
2,5	2,6	5,1	0,6	0,9	1,1	14,28
3	3,1	6,2	0,7	1,1	1,3	8,69
3,5	3,6	6,7	0,7	1,1	1,3	15,11
4	4,1	7,6	0,8	1,2	1,4	11,39
5	5,1	9,2	1	1,5	1,7	15,32
6	6,1	11,8	1,3	2	2,2	26,08
8	8,2	14,8	1,6	2,45	2,75	48,02
10	10,2	18,1	1,8	2,85	3,15	76,59
12	12,2	21,1	2,1	3,35	3,65	99,36
14	14,2	24,1	2,4	3,9	4,3	159
16	16,2	27,4	2,8	4,5	5,1	219
18	18,2	29,4	2,8	4,5	5,1	284
20	20,2	33,6	3,2	5,1	5,9	375
22	22,5	35,9	3,2	5,1	5,9	412
24	24,5	40	4	6,5	7,5	507

Precios en € por 100 unidades. Medidas indicadas en m/m



## TUERCA MARIPOSA TIPO AMERICANO

### WING NUTS, AMERICAN TYPE

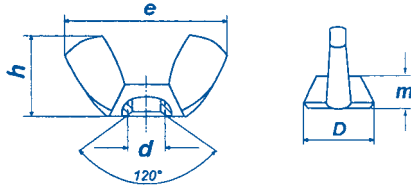

d	D	e	m	h	PRECIO
M-3	7,8	17,6	2,9	8,6	128
M-4	7,8	17,6	2,9	8,6	128
M-5	9,5	22	4	10,5	120
M-6	11,9	27	5	13	144
M-8	13,5	30,3	5,4	14,8	244
M-10	15,3	35,5	6,3	17,3	352
M-12	20,5	47,5	8	22,1	706
M-14	25,5	66	10,6	30,8	2.298
M-16	25,5	66	10,6	30,8	3.308

Precios en € por 100 unidades. Medidas indicadas en m/m

## ARANDELA PARA TORNILLOS CABEZA CILÍNDRICA

### WASHERS FOR CHEESE HEAD SCREWS

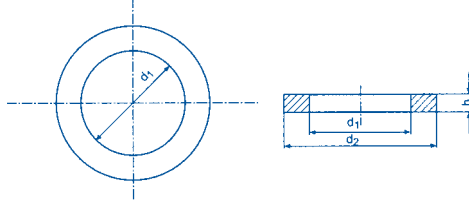

M	$d_1$	$d_2$	h	PRECIO
1,6	1,7	3,5	0,3	26,08
2	2,2	4,5	0,3	26,08
2,5	2,7	5	0,5	26,08
3	3,2	6	0,5	5,18
3,5	3,7	7	0,5	10,76
4	4,3	8	0,5	7,66
5	5,3	9	1	9,73
6	6,4	11	1,6	15,94
8	8,4	15	1,6	26,50
10	10,5	18	1,6	53,82
12	13	20	2	74,52
14	15	24	2,5	143
16	17	28	2,5	166
18	19	30	2,5	263
20	21	34	3	292

Precios en € por 100 unidades. Medidas indicadas en m/m

# DIN 439

ACERO INOXIDABLE - STAINLESS STEEL

A4  
aisi 316

## TUERCA EXAGONAL BAJA HEXAGON THIN NUTS

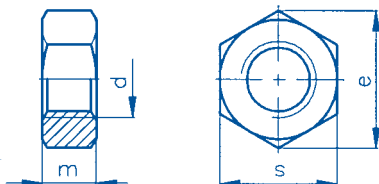

d	s	e	m	PRECIO
M-1,6	3,2	3,48	1	101
M-2	4	4,32	1,2	72,45
M-2,5	5	5,45	1,6	66,24
M-3	5,5	6,01	1,8	16,77
M-4	7	7,66	2,2	18,42
M-5	8	8,79	2,7	21,94
M-6	10	11,05	3,2	26,29
M-8	13	14,38	4	49,89
M-10	17	18,9	5	103
M-12	19	21,1	6	156
M-14	22	24,49	7	476
M-16	24	26,75	8	538
M-18	27	29,56	9	1.153
M-20	30	32,95	10	1.263
M-22	32	35,03	11	1.675
M-24	36	39,55	12	3.064
M-27	41	45,2	13,5	4.310
M-30	46	50,85	15	5.974
M-33	50	55,37	16,5	6.258
M-36	55	60,79	18	8.706
M-39	60	66,44	19,5	9.984
M-42	65	71,3	21	12.716
M-45	70	76,95	22,5	14.304
M-48	75	82,6	24	17.549

Precios en € por 100 unidades. Medidas indicadas en m/m



## TUERCA EXAGONAL BAJA PASO FINO HEXAGON THIN NUTS, FINE PITCH THREAD

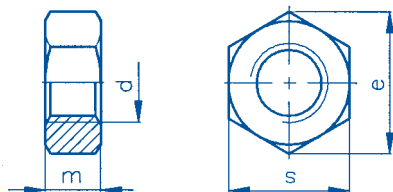

M	s	e	m	PRECIO
8 x 0,75	13	14,38	4	366
8 x 1	13	14,38	4	203
10 x 1	17	18,9	5	319
10 x 1,25	17	18,9	5	422
12 x 1	19	21,1	6	776
12 x 1,25	19	21,1	6	776
12 x 1,5	19	21,1	6	532
14 x 1,5	22	24,49	7	565
16 x 1,5	24	26,75	8	700
18 x 1,5	27	29,56	9	983
20 x 1,5	30	32,95	10	1.292
20 x 2	30	32,95	10	1.292
22 x 1,5	32	35,03	11	1.668
22 x 2	32	35,03	11	1.668
24 x 1,5	36	39,55	12	2.099
24 x 2	36	39,55	12	2.099
27 x 1,5	41	45,2	13,5	2.987
27 x 2	41	45,2	13,5	2.987
30 x 1,5	46	50,85	15	4.252
30 x 2	46	50,85	15	4.252
33 x 2	50	55,37	16,5	6.556

Precios en € por 100 unidades. Medidas indicadas en m/m



## ARANDELA PLANA PARA CONSTRUCCIONES MADERA WASHERS, ESPECIALLY FOR WOOD CONSTRUCTIONS

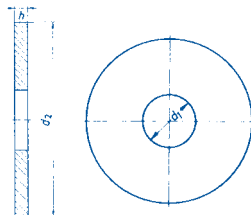

### DIN 440-R

para tornillo	$d_1$	$d_2$	h	PRECIO
M-5	5,5	18	2	145
M-6	6,6	22	2	195
M-8	9	28	3	511
M-10	11	34	3	714
M-12	14	44	4	1.217
M-16	18	56	5	2.153
M-20	22	72	6	3.229
M-22	24	80	6	3.767
M-24	26	85	6	4.117

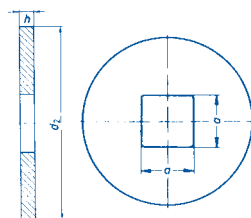

### DIN 440-V

para tornillo	a	$d_2$	h	PRECIO
M-5	5,5	18	2	741
M-6	6,6	22	2	1.126
M-8	9	28	3	1.712
M-10	11	34	3	2.360
M-12	14	44	4	2.656
M-16	18	56	5	4.016
M-20	22	72	6	5.336
M-24	26	85	6	7.050

Precios en € por 100 unidades. Medidas indicadas en m/m



## TORNILLOS CON OJO FORMA B

### EYE BOLTS FORM B

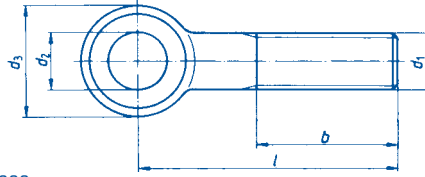

①  $L \leq 125$  mm

②  $125$  mm  $< L \leq 200$  mm

$b$ ①	18	22	26	30	38	46	54
$b$ ②		28	32	36	44	52	60
$d_2$	6	8	10	12	16	18	22
$d_3$	14	18	20	25	32	40	45

$d_1$	M-6	M-8	M-10	M-12	M-16	M-20	M-24
L 30	1.292	1.517					
35	1.422	1.517					
40	1.422	1.695	2.068				
45	1.584	1.803	2.325				
50	1.679	1.938	2.472	3.326			
55	1.760	2.002	2.583	3.440			
60	1.840	2.035	2.714	3.521	5.167		
65		2.116	2.875	3.552	5.328		
70		2.163	3.006	3.552	5.570	8.557	
75		2.260	3.101	3.714	5.974	8.557	
80		2.294	3.148	3.972	6.204	8.557	10.818
90		2.509	3.213	4.198	6.427	9.338	11.302
100		2.815	3.505	4.608	6.556	9.715	11.820
110			3.811	5.069	6.717	10.321	12.325
120			4.037	5.204	6.943	10.464	12.755
130				7.363	7.266	10.725	13.078
140				7.411	7.524	11.033	13.821
150				7.549	7.723	11.625	14.208

Precios en € por 100 unidades. Medidas indicadas en m/m

## ARANDELA DE SEGURIDAD CON DOS SOLAPAS TAB WASHERS WITH TWO TABS

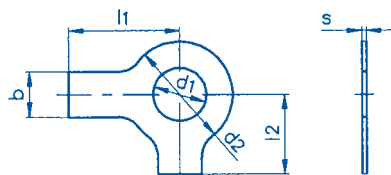

para Tornillo	d <sub>1</sub>	d <sub>2</sub>	l <sub>1</sub>	l <sub>2</sub>	b	s	PRECIO
M-4	4,3	9	14	6,5	5	0,4	377
M-5	5,3	10	16	8	6	0,5	391
M-6	6,4	12,5	18	9	7	0,5	400
M-8	8,4	17	20	11	8	0,75	511
M-10	10,5	21	22	13	10	0,75	673
M-12	13	24	28	15	12	1	861
M-14	15	28	28	16	12	1	996
M-16	17	30	32	18	15	1	1.265
M-18	19	34	36	20	18	1	1.372
M-20	21	37	36	21	18	1	1.521
M-22	23	39	42	23	20	1	1.830
M-24	25	44	42	25	20	1	1.938
M-27	28	50	48	29	23	1,6	3.310
M-30	31	56	52	32	26	1,6	3.525
M-33	34	60	56	34	28	1,6	4.037
M-36	37	66	60	38	30	1,6	4.751
M-39	40	72	64	41	32	1,6	5.100

Precios en € por 100 unidades. Medidas indicadas en m/m

### TUERCA CUADRADA SQUARE NUTS

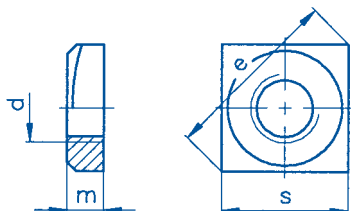

#### DIN 557

d	s	e	m	PRECIO
M-5	8	11,3	4	153
M-6	10	14,1	5	188
M-8	13	18,4	6,5	296
M-10	17	24	8	1.201
M-12	19	26,9	10	1.830

### TUERCA CUADRADA REBAJADA SQUARE THIN NUTS

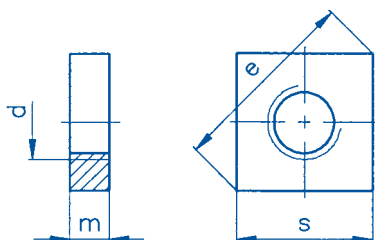

#### DIN 562

d	s	e	m	PRECIO
M-3	5,5	7	1,8	97,29
M-4	7	8,9	2,2	122
M-5	8	10,2	2,7	151
M-6	10	12,7	3,2	219
M-8	13	16,5	4	306
M-10	17	21,8	5	553

Precios en € por 100 unidades. Medidas indicadas en m/m

# DIN 571

ACERO INOXIDABLE - STAINLESS STEEL

A4  
aisi 316

## TIRAFONDO CABEZA EXAGONAL HEXAGON HEAD WOOD SCREWS

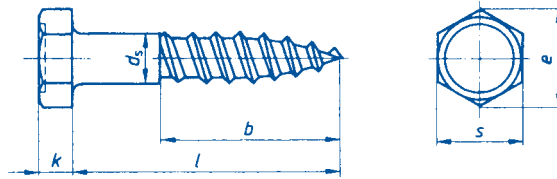

b	b ≥ 0,6 L						
k	2,8	3,5	4	5	5,5	7	8
e	7,5	8,63	10,89	13,07	14,2	18,72	20,88
s	7	8	10	12	13	17	19

d <sub>s</sub>	4	5	6	7	8	10	12
L 20	178						
25	172	98,33	108				
30	161	81,14	86,32		179		
35	201	114	124		179		
40	219	91,70	95,63	190	146	362	
45		130	142	219	188	375	
50		104	110	219	168	375	1.124
60		144	154	250	192	408	1.223
70			198	339	277	457	1.372
80			244	474	364	559	1.677
90			311	604	466	863	2.157
100			406	687	528	973	2.432
110			594	878	675	1.273	3.182
120			712	1.070	822	1.354	3.384
130					888	1.490	3.728
140					1.356	1.693	4.233
150					1.567	1.938	4.844
160					1.747	2.178	5.444

Precios en € por 100 unidades. Medidas indicadas en m/m



Hispanox s.a.

Tel. 93 729 99 60 - Fax 93 729 99 61

## TORNILLO CON CUELLO CUADRADO MUSHROOM HEAD SQUARE NECK BOLTS

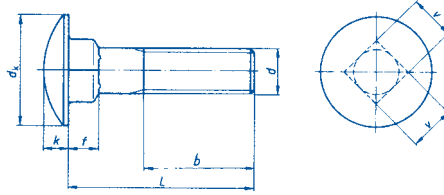

V min.	4,52	5,52	7,42	9,42	11,3	15,3
F max.	4,1	4,6	5,6	6,6	8,75	12,9
K max.	3,3	3,88	4,88	5,38	6,95	8,95
dk max	13,55	16,55	20,65	24,65	30,65	38,80
b L ≤ 125	16	18	22	26	30	38
b 125 < L ≤ 200	22	24	28	32	36	44

d	M-5	M-6	M-8	M-10	M-12	M-16
L 16	156	164	302			
20	120	126	209	727		
25	133	140	244	727		
30	151	159	277	741	2.194	3.548
35	164	173	302	830	2.314	3.747
40	188	198	339	845	2.434	3.709
45	207	217	371	925	2.554	3.919
50	232	244	410	971	2.679	4.059
55	335	354	511	1.101	2.799	4.409
60	335	354	511	1.101	2.919	4.409
65	486	513	642	1.232	3.037	4.827
70	486	513	642	1.232	3.037	4.827
80		625	753	1.610	3.279	5.177
90		720	900	1.722	3.399	5.492
100		834	1.099	1.857	3.637	6.088
110			1.174	2.517	4.119	6.403
120			1.290	2.685	4.364	6.841
130				2.852	4.614	7.208
140				3.018	4.867	7.558
150				3.169	5.123	8.116

Precios en € por 100 unidades. Medidas indicadas en m/m



HISPANOX, una empresa con madera de líder; y todo ello gracias a la confianza de nuestros clientes.

## TORNILLO CILINDRICO CON EXAGONO INTERIOR

### HEXAGON SOCKET HEAD CAP SCREWS

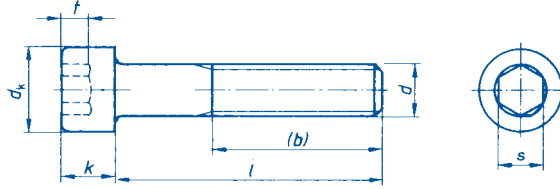

<b>b*</b>	16	17	18	20	22	24	28	32
<b>t min.</b>	1	1,1	1,3	2	2,5	3	4	5
<b>s</b>	1,5	2	2,5	3	4	5	6	8
<b>k max.</b>	2	2,5	3	4	5	6	8	10
<b>dk</b>	3,8	4,5	5,5	7	8,5	10	13	16

<b>d</b>	<b>M-2</b>	<b>M-2,5</b>	<b>M-3</b>	<b>M-4</b>	<b>M-5</b>	<b>M-6</b>	<b>M-8</b>	<b>M-10</b>
<b>L 3</b>	170	170						
<b>4</b>	170	170	65,21					
<b>5</b>	161	161	55,48	88,39				
<b>6</b>	161	161	44,92	63,34	69,76			
<b>8</b>	161	161	44,92	45,95	48,44	49,27		
<b>10</b>	170	170	34,78	28,57	30,43	38,71	84,66	
<b>12</b>	178	178	36,43	28,57	30,43	32,50	84,66	
<b>16</b>	197	197	38,92	29,08	31,26	34,36	67,90	148
<b>20</b>	232	232	41,19	30,84	33,95	38,30	72,86	117
<b>25</b>			53,61	34,78	38,09	43,26	82,18	129
<b>30</b>			69,76	40,78	43,88	49,27	92,74	140
<b>35</b>			82,39	46,16	50,51	56,51	106	153
<b>40</b>			90,05	51,96	56,10	62,72	115	162
<b>45</b>				67,07	72,04	74,31	127	181
<b>50</b>				72,86	74,93	78,45	137	200
<b>55</b>					92,74	97,50	162	244
<b>60</b>					92,74	97,50	162	244
<b>65</b>					144	119	189	288
<b>70</b>					144	119	189	288
<b>80</b>						211	250	342
<b>90</b>						267	410	420
<b>100</b>						306	457	486
<b>110</b>							571	609
<b>120</b>							714	892

Precios en € por 100 unidades. Medidas indicadas en m/m



## TORNILLO CILINDRICO CON EXAGONO INTERIOR HEXAGON SOCKET HEAD CAP SCREWS

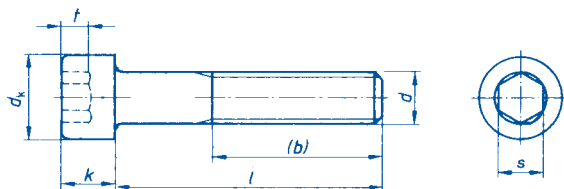

<b>h*</b>	36	40	44	48	52	60
<b>t min.</b>	6	7	8	9	10	12
<b>s</b>	10	12	14	14	17	19
<b>k max.</b>	12	14	16	18	20	24
<b>dk</b>	18	21	24	27	30	36

d	M-12	M-14	M-16	M-18	M-20	M-24
<b>L 20</b>	199					
<b>25</b>	175	869				
<b>30</b>	198	869	725			
<b>35</b>	217	917	764			
<b>40</b>	238	1.010	840	6.856	4.571	8.684
<b>45</b>	261	1.103	919	6.988	4.660	8.853
<b>50</b>	279	1.157	965	7.473	4.982	9.468
<b>55</b>	329	1.296	1.087	7.967	5.312	10.093
<b>60</b>	329	1.296	1.087	7.967	5.312	10.093
<b>65</b>	385	1.528	1.281	8.454	5.637	10.710
<b>70</b>	385	1.528	1.281	8.454	5.637	10.710
<b>75</b>	462	1.824	1.519	8.963	5.976	11.354
<b>80</b>	462	1.824	1.519	8.963	5.976	11.354
<b>90</b>	540	2.370	1.824	10.638	7.092	13.476
<b>100</b>	607	2.844	2.186	11.652	7.769	14.761
<b>110</b>	932	3.413	2.625	13.981	9.323	17.713
<b>120</b>	1.118	4.094	3.151	16.777	11.188	21.257
<b>130</b>	1.366		3.780		13.426	25.509
<b>140</b>	1.646		4.535		16.109	30.605
<b>150</b>	1.896		5.444		19.332	36.786
<b>160</b>			6.533		23.196	41.354

Precios en € por 100 unidades. Medidas indicadas en m/m

## ESPARRAGO ROSCADO CON EXAGONO INTERIOR PUNTA PLANA

### HEXAGON SOCKET SET SCREWS WITH FLAT POINT

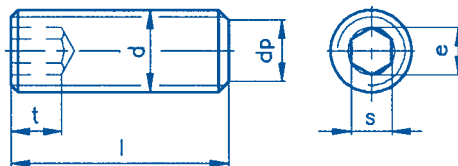

$d_p$ max.	2	2,5	3,5	4	5,5	7	8,5	12	15
t min.	1,2	1,5	2	2	3	4	4,8	6,4	8
e	1,73	2,3	2,87	3,44	4,58	5,72	6,86	9,15	11,43
s	1,5	2	2,5	3	4	5	6	8	10

d	M-3	M-4	M-5	M-6	M-8	M-10	M-12	M-16	M-20
L 3	48	54							
4	53	58	66						
5	55	61	72	74					
6	57	63	75	80	102				
8	60	66	80	82	112	153			
10	63	68	84	88	120	162	420		
12	74	80	90	101	130	191	440	1.613	
16	77	85	102	115	156	250	500	1.830	4.037
20	90	101	115	125	174	265	540	2.180	4.037
25	102	115	124	147	188	280	570	2.329	4.171
30		130	172	173	222	297	610	2.347	4.171
35			198	208	250	334	660	2.449	4.575
40				224	277	370	720	2.679	4.709
45				273	300	410	780	2.906	4.844
50					318	460	850	3.095	4.844
60							990	4.010	6.458
70							1.110	4.306	6.997
80									7.535

Precios en € por 100 unidades. Medidas indicadas en m/m

## ESPARRAGO ROSCADO CON EXAGONO INTERIOR PUNTA CONICA HEXAGON SOCKET SET SCREWS WITH CONE POINT

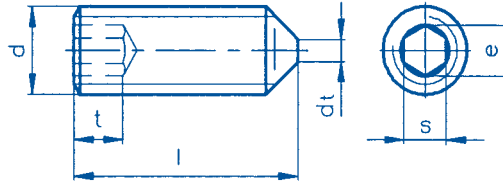

<b>d, max.</b>	0,4	0,5	1	1,5	2	2,5	3	4	5
<b>t min.</b>	1,2	1,5	2	2	3	4	4,8	6,4	8
<b>e</b>	1,73	2,3	2,87	3,44	4,58	5,72	6,86	9,15	11,43
<b>s</b>	1,5	2	2,5	3	4	5	6	8	10

<b>d</b>	<b>M-3</b>	<b>M-4</b>	<b>M-5</b>	<b>M-6</b>	<b>M-8</b>	<b>M-10</b>	<b>M-12</b>	<b>M-16</b>	<b>M-20</b>
<b>L 3</b>	48	54							
<b>4</b>	53	58	66						
<b>5</b>	55	61	72	74					
<b>6</b>	57	63	75	80	102				
<b>8</b>	60	66	80	82	112	153			
<b>10</b>	63	68	84	88	120	162	420		
<b>12</b>	74	80	90	101	130	191	440	1.613	
<b>16</b>	77	85	102	115	156	250	500	1.830	4.037
<b>20</b>	90	101	115	125	174	265	540	2.180	4.037
<b>25</b>	102	115	124	147	188	280	570	2.329	4.171
<b>30</b>		130	172	173	222	297	610	2.347	4.171
<b>35</b>			198	208	250	334	660	2.449	4.575
<b>40</b>				224	277	370	720	2.679	4.709
<b>45</b>				273	300	410	780	2.906	4.844
<b>50</b>					318	460	850	3.095	4.844
<b>60</b>							990	4.010	6.458
<b>70</b>							1.110	4.306	6.997
<b>80</b>									7.535

Precios en € por 100 unidades. Medidas indicadas en m/m



### ESPARRAGO ROSCADO CON EXAGONO INTERIOR PUNTA DE PIVOTE HEXAGON SOCKET SET SCREWS WITH DOG POINT

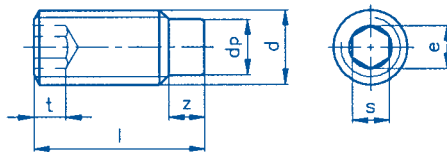

$d_p$ max.	2	2,5	3,5	4	5,5	7	8,5	12	15
t min.	1,2	1,5	2	2	3	4	4,8	6,4	8
e	1,73	2,3	2,87	3,44	4,58	5,72	6,86	9,15	11,43
s	1,5	2	2,5	3	4	5	6	8	10

d	M-3	M-4	M-5	M-6	M-8	M-10	M-12	M-16	M-20
L 3	48	54							
4	53	58	66						
5	55	61	72	74					
6	57	63	75	80	102				
8	60	66	80	82	112	153			
10	63	68	84	88	120	162	420		
12	74	80	90	101	130	191	440	1.613	
16	77	85	102	115	156	250	500	1.830	4.037
20	90	101	115	125	174	265	540	2.180	4.037
25	102	115	124	147	188	280	570	2.329	4.171
30		130	172	173	222	297	610	2.347	4.171
35			198	208	250	334	660	2.449	4.575
40				224	277	370	720	2.679	4.709
45				273	300	410	780	2.906	4.844
50					318	460	850	3.095	4.844
60							990	4.010	6.458
70							1.110	4.306	6.997
80									7.535

Precios en € por 100 unidades. Medidas indicadas en m/m

## ESPARRAGO ROSCADO CON EXAGONO INTERIOR PUNTA CON CHAFLAN Y CONO INTERNO HEXAGON SOCKET SET SCREWS WITH CUP POINT

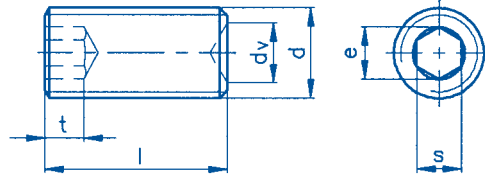

<b>d<sub>v</sub> max.</b>	1,4	2	2,5	3	5	6	8	10	14
<b>t min.</b>	1,2	1,5	2	2	3	4	4,8	6,4	8
<b>e</b>	1,73	2,3	2,87	3,44	4,58	5,72	6,86	9,15	11,43
<b>s</b>	1,5	2	2,5	3	4	5	6	8	10

d	M-3	M-4	M-5	M-6	M-8	M-10	M-12	M-16	M-20
<b>L 3</b>	48	54							
<b>4</b>	53	58	66						
<b>5</b>	55	61	72	74					
<b>6</b>	57	63	75	80	102				
<b>8</b>	60	66	80	82	112	153			
<b>10</b>	63	68	84	88	120	162	420		
<b>12</b>	74	80	90	101	130	191	440	1.613	
<b>16</b>	77	85	102	115	156	250	500	1.830	4.037
<b>20</b>	90	101	115	125	174	265	540	2.180	4.037
<b>25</b>	102	115	124	147	188	280	570	2.329	4.171
<b>30</b>		130	172	173	222	297	610	2.347	4.171
<b>35</b>			198	208	250	334	660	2.449	4.575
<b>40</b>				224	277	370	720	2.679	4.709
<b>45</b>				273	300	410	780	2.906	4.844
<b>50</b>					318	460	850	3.095	4.844
<b>60</b>							990	4.010	6.458
<b>70</b>							1.110	4.306	6.997
<b>80</b>									7.535

Precios en € por 100 unidades. Medidas indicadas en m/m

### TUERCAS DE SOMBRERETE EXAGONALES FORMA BAJA HEXAGON CAP NUTS

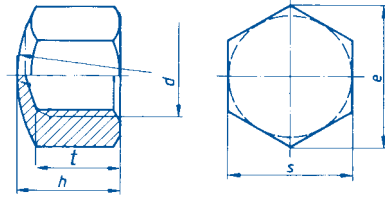

d	s	h	t min.	PRECIO
M-4	7	5,5	4,16	149
M-5	8	7	4,96	170
M-6	10	9	6,71	199
M-8	13	12	9,21	261
M-10	17	14	10,65	437
M-12	19	16	13,15	671
M-14	22	18	14,65	1.199
M-16	24	20	16,65	1.199
M-18	27	22	18,58	2.140
M-20	30	25	20,58	2.140
M-22	32	28	21,58	3.633
M-24	36	30	23,58	3.633
M-27	41	32	25,58	6.458
M-30	46	34	27,58	8.477

Precios en € por 100 unidades. Medidas indicadas en m/m

## TUERCAS PARA SOLDAR - CUADRADAS SQUARE WELD NUTS

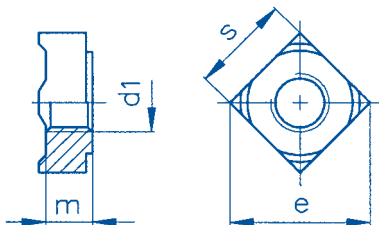

### DIN 928

$d_1$	s	e	m	PRECIO
M-5	8	11	4,2	286
M-6	10	13	5	360
M-8	14	18	6,5	418

## TUERCAS PARA SOLDAR - EXAGONALES HEXAGON WELD NUTS

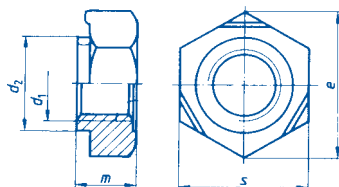

### DIN 929

$d_1$	s	e	m	$d_2$	PRECIO
M-3	7,5	8,15	3	4,5	184
M-4	9	9,83	3,5	6	195
M-5	10	10,95	4	7	205
M-6	11	12,02	5	8	257
M-8	14	15,38	6,5	10,5	298
M-10	17	18,74	8	12,5	464
M-12	19	20,91	10	14,8	861
M-16	24	26,51	13	18,8	1.507

Precios en € por 100 unidades. Medidas indicadas en m/m

## TORNILLO CABEZA EXAGONAL ROSCA PARCIAL HEXAGON HEAD BOLTS

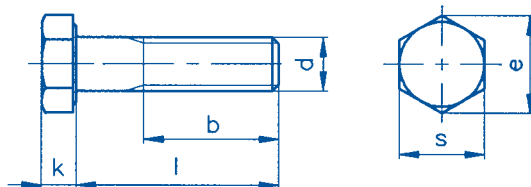

<b>k</b>	4	5,3	6,4	7,5	8,8	10	11,5
<b>e</b>	11,05	14,38	18,90	21,10	24,49	26,75	30,14
<b>s</b>	10	13	17	19	22	24	27
<b>b para L ≤ 125</b>	18	22	26	30	34	38	42
<b>b para 125 &lt; L ≤ 200</b>	24	28	32	36	40	44	48
<b>b para L &gt; 200</b>	-	-	45	49	53	57	61

<b>d</b>	<b>M-6</b>	<b>M-8</b>	<b>M-10</b>	<b>M-12</b>	<b>M-14</b>	<b>M-16</b>	<b>M-18</b>
<b>L 30</b>	60,86						
<b>35</b>	68,52	142					
<b>40</b>	76,38	142	255	348			
<b>45</b>	84,04	151	255	348			
<b>50</b>	90,67	158	261	358	708	737	
<b>55</b>	122	182	294	402	727	745	
<b>60</b>	111	185	304	412	727	749	2.058
<b>65</b>	137	209	327	437	778	836	2.167
<b>70</b>	142	228	339	466	818	867	2.213
<b>75</b>	207	279	395	546	915	973	2.521
<b>80</b>	207	279	395	546	915	973	2.521
<b>90</b>	296	323	435	611	1.056	1.153	2.749
<b>100</b>	358	375	526	667	1.196	1.250	2.958
<b>110</b>	431	511	667	751	1.223	1.397	3.320
<b>120</b>	518	557	749	874	1.358	1.461	3.523
<b>130</b>	621	667	886	1.068	1.714	2.024	4.699
<b>140</b>	743	801	1.047	1.261	1.944	2.246	5.297
<b>150</b>	894	960	1.230	1.424	2.138	2.420	5.891
<b>160</b>		1.153	1.370	1.584	2.826	2.596	6.485
<b>170</b>		1.385	1.687	1.900	3.279	3.492	7.079
<b>180</b>		1.662	2.004	2.231	3.513	4.055	7.673
<b>190</b>		2.167	2.320	2.563	3.954	4.655	8.268
<b>200</b>		2.505	2.641	2.894	4.430	5.301	8.837
<b>210</b>			3.432	3.761		6.202	
<b>220</b>			4.463	4.546		6.843	
<b>230</b>				5.415		8.098	
<b>240</b>				6.498		9.499	
<b>250</b>						11.621	

Precios en € por 100 unidades. Medidas indicadas en m/m



## TORNILLO CABEZA EXAGONAL ROSCA PARCIAL HEXAGON HEAD BOLTS

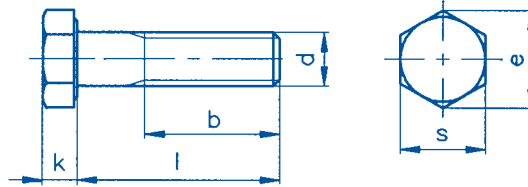

<b>k</b>	12,5	14	15	17	18,7	21	22,5
<b>e</b>	33,53	35,72	39,98	45,20	50,85	55,37	60,79
<b>s</b>	30	32	36	41	46	50	55
<b>h para L ≤ 125</b>	46	50	54	60	66	72	78
<b>h para 125 &lt; L &lt; 200</b>	52	56	60	66	72	78	84
<b>h para L &gt; 200</b>	65	69	73	79	85	91	97

<b>d</b>	<b>M-20</b>	<b>M-22</b>	<b>M-24</b>	<b>M-27</b>	<b>M-30</b>	<b>M-33</b>	<b>M-36</b>
<b>L 65</b>	1.565						
<b>70</b>	1.581		3.848				
<b>75</b>	1.801		4.250				
<b>80</b>	1.801	5.100	4.250	6.539	8.174		
<b>90</b>	1.962	5.552	4.626	7.131	8.913	13.327	
<b>100</b>	2.111	6.316	5.264	7.723	9.654	13.327	16.258
<b>110</b>	2.370	7.086	5.906	8.315	10.393	14.349	17.506
<b>120</b>	2.515	7.700	6.417	8.880	11.101	15.326	18.696
<b>130</b>	3.358	8.251	6.874	9.203	11.503	15.879	19.371
<b>140</b>	3.784	8.773	7.311	9.768	12.209	16.800	20.497
<b>150</b>	4.107	9.607	8.007	10.333	12.917	17.889	21.805
<b>160</b>	4.724	10.396	8.663	10.925	13.656	18.851	22.987
<b>170</b>	5.904		9.454	12.056	15.070	20.801	25.378
<b>180</b>	7.721	12.360	10.300	12.652	15.815	21.830	26.635
<b>190</b>	9.226		11.329	13.753	17.191	23.733	28.953
<b>200</b>	11.532	14.956	12.461	16.494	20.617	28.460	34.722
<b>210</b>	12.687		13.710	18.508	23.134	31.938	38.964
<b>220</b>	13.952		15.080	20.358	25.449	35.132	42.861
<b>230</b>	15.349		16.587	22.391	27.988	38.637	47.138
<b>240</b>	16.883		18.247	24.635	30.793	42.510	51.862
<b>250</b>	18.572		20.073	27.096	33.869	46.755	57.041

Precios en € por 100 unidades. Medidas indicadas en m/m



## TORNILLO CABEZA EXAGONAL HEXAGON HEAD SCREWS

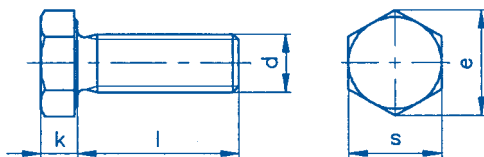

k	1,4	1,7	2	2,8	3,5	4	5,3	6,4	7,5	8,8
e	4,32	5,45	6,01	7,66	8,79	11,05	14,38	18,9	21,1	24,49
s	4	5	5,50	7	8	10	13	17	19	22

d	M-2	M-2,5	M-3	M-4	M-5	M-6	M-8	M-10	M-12	M-14
L 5	242	242								
6	253	253	34,36	24,90						
8	271	271	23,60	18,13	24,22					
10	296	296	23,60	18,13	22,56	27,95	58,58			
12	313	313	25,25	19,35	22,56	27,12	56,30	139		
14	377	377	35,60	27,32	30,84	36,02	67,28			
16	344	344	27,32	20,91	23,60	27,74	51,54	104	174	
18				30,95	34,16	37,88	72,66			
20	391	391	31,26	23,81	26,29	29,19	55,68	105	174	400
22				35,40	38,09	43,68	81,14			
25			35,40	27,12	29,19	33,53	62,31	110	166	362
30			40,16	30,84	33,33	38,92	69,76	117	173	344
35				34,78	36,02	43,88	77,00	131	187	360
40				40,57	41,19	48,65	82,18	135	200	385
45				54,86	49,47	53,20	88,80	155	221	416
50				63,76	61,27	57,55	93,87	161	230	443
55					72,86	67,48	103	175	263	484
60				117	74,73	67,48	107	186	275	509
65						76,18	118	203	300	582
70					132	76,18	126	203	311	582
75						85,28	146	232	344	667
80					247	85,28	146	232	344	667
90						110	190	304	410	749
100						142	232	350	511	820
110							302	489	687	1.128
120							350	617	882	1.350
130							455	801	1.145	1.753
140							592	1.043	1.488	2.279
150							770	1.354	1.935	2.964

## TORNILLO CABEZA EXAGONAL HEXAGON HEAD SCREWS

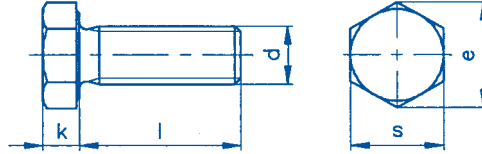

<b>k</b>	10	11,5	12,5	14	15	17	18,7	21	22,5
<b>e</b>	26,75	30,14	33,53	35,72	39,98	45,2	50,85	55,37	60,79
<b>s</b>	24	27	30	32	36	41	46	50	55

<b>d</b>	<b>M-16</b>	<b>M-18</b>	<b>M-20</b>	<b>M-22</b>	<b>M-24</b>	<b>M-27</b>	<b>M-30</b>	<b>M-33</b>	<b>M-36</b>
<b>L 20</b>	402								
<b>25</b>	364								
<b>30</b>	373	1.018	849						
<b>35</b>	391	853	710						
<b>40</b>	397	884	737	2.540	1.913				
<b>45</b>	431	917	764	2.540	1.913				
<b>50</b>	453	946	789	2.540	1.954	4.914			
<b>55</b>	491	1.033	861	2.879	2.180	4.914			
<b>60</b>	518	1.054	878	2.939	2.260	5.167	6.777		
<b>65</b>	575	1.165	977	3.076	2.374	5.719	6.777		
<b>70</b>	588	1.199	1.000	3.122	2.472	5.719	7.075	9.083	
<b>75</b>	673	1.389	1.157	3.515	2.703	6.144	7.541	10.899	
<b>80</b>	673	1.389	1.157	3.515	2.703	6.144	7.541	10.899	13.443
<b>90</b>	747	1.610	1.341	3.865	3.206	6.610	8.259	11.667	14.370
<b>100</b>	795	1.741	1.451	4.169	3.699	7.032	9.106	12.917	16.146
<b>110</b>	1.236	2.176	1.813	5.560	4.165	7.624	9.659	13.766	16.995
<b>120</b>	1.395	2.720	2.267	6.073	4.782	8.048	10.168	14.612	17.841
<b>130</b>	1.652	3.399	2.834	6.941	5.976	8.473	10.801	15.527	18.810
<b>140</b>	1.840	4.020	3.349	7.903	6.872	9.106	11.437	15.662	19.348
<b>150</b>	2.165	5.024	4.188	9.141	7.903	9.741	12.072	16.119	19.752
<b>160</b>	2.712		5.233		9.483				
<b>170</b>	3.384		6.282		11.381				
<b>180</b>	4.229		7.535		13.656				
<b>190</b>	5.287		9.042		16.388				
<b>200</b>	6.607		10.849		19.669				

Precios en € por 100 unidades. Medidas indicadas en m/m

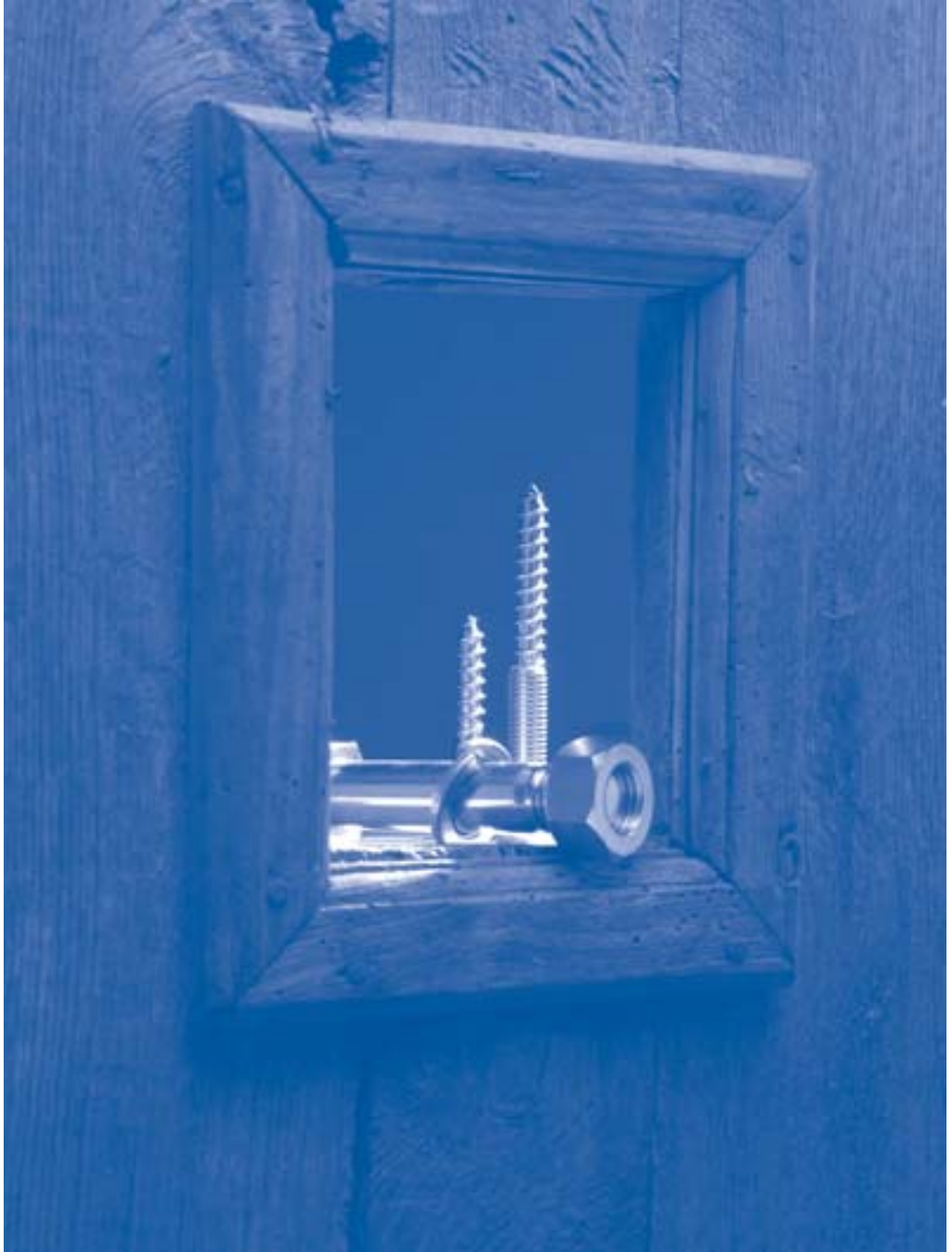

Entra, mira, observa y lo que NO encuentres en nuestro catálogo, CONSÚLTALO. Podemos ofrecerles todo tipo de piezas especiales sin ningún compromiso.

## TORNILLO EXAGONAL ROSCA UNC - WHITWORTH HEXAGON HEAD SCREWS - WHITWORTH

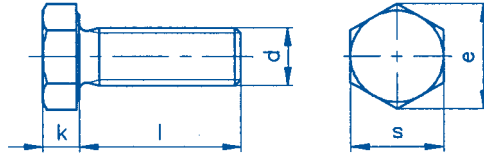

	UNC	UNC	UNC	UNC	UNC	UNC	W
k	4	5,2	6	7,9	9,9	11,9	7,9
s	11,1	12,7	14,3	19	23,8	28,6	20,8
Paso h	20	18	16	13	11	10	12

d	UNC						W
	1/4	5/16	3/8	1/2	5/8	3/4	1/2
L 9,5	221						
13	238						
16	248	849					
19	269	1.035	987	1.377			1.377
25	286	1.076	1.039	1.432			1.432
32	327	1.143	1.087	1.553	3.947	6.059	1.553
38	393	1.439	1.267	1.786	4.502	6.769	1.786
45	435	1.490	1.329	1.894	4.633	7.131	1.894
50	447	1.573	1.387	1.950	4.751	7.477	1.950
63	530	1.743	1.610	2.002	5.123	7.994	2.002
75		1.946	1.929	2.438	5.724	8.988	2.438
100		3.302	2.656	3.198	6.469	13.689	3.198

Precios en € por 100 unidades. Medidas indicadas en m/m



### TUERCA EXAGONAL HEXAGON NUTS

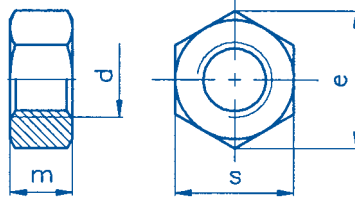

d	s	e	m	PRECIO
M-1,6	3,2	3,48	1,3	253
M-2	4	4,38	1,6	70,38
M-2,5	5	5,45	2	70,38
M-3	5,5	6,01	2,4	5,38
M-3,5	6	6,58	2,8	54,65
M-4	7	7,66	3,2	6,00
M-5	8	8,79	4	7,25
M-6	10	11,05	5	10,97
M-7	11	12,12	5,5	76,18
M-8	13	14,38	6,5	21,74
M-10	17	18,9	8	48,23
M-12	19	21,1	10	72,04
M-14	22	24,49	11	109
M-16	24	26,75	13	145
M-18	27	29,56	15	240
M-20	30	32,95	16	294
M-22	32	35,03	18	435
M-24	36	39,55	19	565
M-27	41	45,2	22	1.807
M-30	46	50,85	24	2.037
M-33	50	55,37	26	3.985
M-36	55	60,79	29	5.817
M-39	60	66,44	31	9.139
M-42	65	72,09	34	11.302
M-45	70	76,95	36	16.415
M-48	75	82,6	38	21.487
M-52	80	88,25	42	26.918

Precios en € por 100 unidades. Medidas indicadas en m/m

## TUERCA EXAGONAL ROSCA IZQUIERDA HEXAGON NUTS LEFT HAND THREAD

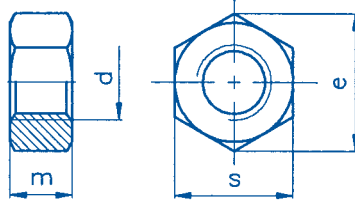

d	s	e	m	PRECIO
M-5-I	8	8,79	4	168
M-6-I	10	11,05	5	172
M-8-I	13	14,38	6,5	267
M-10-I	17	18,9	8	584
M-12-I	19	21,1	10	818
M-14-I	22	24,49	11	1.147
M-16-I	24	26,75	13	1.306
M-18-I	27	29,56	15	1.964
M-20-I	30	32,95	16	2.329
M-22-I	32	35,03	18	3.498
M-24-I	36	39,55	19	3.767
M-27-I	41	45,2	22	6.997
M-30-I	46	50,85	24	8.853

Precios en € por 100 unidades. Medidas indicadas en mm

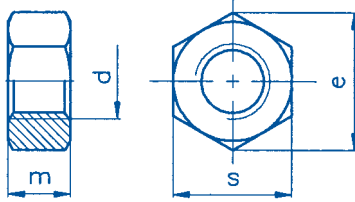
**TUERCA EXAGONAL PASO FINO**  
 HEXAGON NUTS FINE PITCH

d	s	e	m	PRECIO
M 8 x 1	13	14,38	6,5	176
M 10 x 1	17	18,9	8	311
M 10 x 1,25	17	18,9	8	404
M 12 x 1,25	19	21,1	10	646
M 12 x 1,50	19	21,1	10	484
M 14 x 1,50	22	24,49	11	673
M 16 x 1,50	24	26,75	13	673
M 18 x 1,50	27	29,56	15	1.211
M 20 x 1,50	30	32,95	16	1.211
M 20 x 2	30	32,95	16	1.588
M 22 x 1,5	32	35,03	18	2.153
M 24 x 1,5	36	39,55	19	2.153
M 24 x 2	36	39,55	19	2.691
M 27 x 1,5	41	45,2	22	4.037
M 27 x 2	41	45,2	22	5.113
M 30 x 1,5	46	50,85	24	6.458
M 30 x 2	46	50,85	24	6.458
M 36 x 1,5	55	60,79	29	12.917
M 36 x 3	55	60,79	29	12.917

Precios en € por 100 unidades. Medidas indicadas en m/m





## TUERCA EXAGONAL ROSCA WHITWORTH

### HEXAGON NUTS WHITWORTH

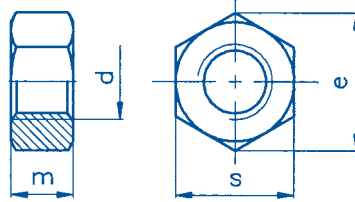

d	m	s	PRECIO
3/16	4,1	8,2	244
1/4	5,1	11,3	209
5/16	6,3	13,3	397
3/8	7,9	15,2	503
7/16	9,5	18,04	646
1/2	11,1	20,8	753
5/8	14,3	25,7	1.215
3/4	17,4	30,5	1.906
7/8	19,1	33,02	2.757
1	22,2	37,6	3.809
1 1/8	25,4	42,4	6.843
1 1/4	28,6	47,2	7.286
1 3/8	31,8	52,1	9.290
1 1/2	34,9	56,4	11.393

Precios en € por 100 unidades. Medidas indicadas en m/m



## TUERCA EXAGONAL BAJA HEXAGON THIN NUTS

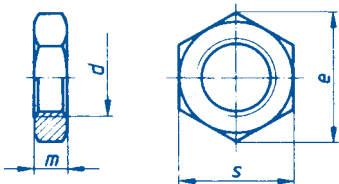

d	s	e	m	PRECIO
M-8	13	14,38	5	49,89
M-10	17	18,9	6	103
M-12	19	21,1	7	156
M-14	22	24,49	8	484
M-16	24	26,75	8	538
M-18	27	29,56	9	1.153
M-20	30	32,95	9	1.263
M-22	32	35,03	10	1.675
M-24	36	39,55	10	3.064
M-27	41	45,2	12	4.310
M-30	46	50,85	12	5.974
M-33	50	55,37	14	6.258
M-36	55	60,79	14	8.706
M-39	60	66,44	16	9.984
M-42	65	71,3	16	12.716

Precios en € por 100 unidades. Medidas indicadas en mm

## TORNILLO CABEZA AVELLANADA PLANA CON RANURA SLOTTED COUNTERSUNK HEAD SCREWS

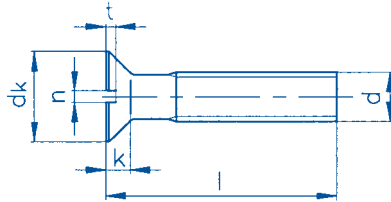

t min.	0,32	0,4	0,5	0,6	0,8	1	1,2	1,6	2	2,4	3,2
n	0,4	0,5	0,6	0,8	1	1,2	1,6	2	2,5	3	4
k	0,96	1,2	1,5	1,65	2,2	2,5	3	4	5	6	8
dk	3	3,8	4,7	5,6	7,5	9,2	11	14,5	18	22	29

d	M-1,6	M-2	M-2,5	M-3	M-4	M-5	M-6	M-8	M-10	M-12	M-16
L 4	64,17	24,22	24,22	39,33							
5	62,10	17,60	17,60	37,26	41,40						
6	62,10	18,42	18,42	10,56	15,32	22,15					
8	62,10	18,84	18,84	10,14	14,92	20,49	40,78				
10	64,17	21,32	21,32	9,77	12,48	19,67	24,01	127			
12		22,98	22,98	10,76	13,31	21,05	25,25	100			
14			37,67	17,91	21,53	34,36	40,78				
16		24,22	24,22	11,92	14,95	23,81	27,95	71,83	296		
18			60,03	20,08	23,81	36,85	44,30				
20		32,29	32,29	13,70	16,66	26,50	31,88	77,21	226	805	
25		49,68	49,68	19,04	21,11	31,26	38,30	86,73	253	745	3.074
30				23,18	25,88	33,95	44,09	103	271	756	3.153
35					35,23	48,85	57,75	134	294	791	3.279
40					43,68	59,00	67,07	144	333	880	3.451
45					67,90	70,59	92,32	190	389	1.116	3.544
50					67,90	75,97	98,74	219	428	1.155	3.709
60					98,50	103	133	277	528	1.408	3.906
70						163	201	344	648	1.594	4.130
80						204	253	420	766	1.952	4.492
90						277	333	534	921	2.420	5.353
100						387	400	594	1.016	2.577	6.196
110								1.060	1.613	2.881	6.707
120								1.228	1.857	3.175	7.028

Precios en € por 100 unidades. Medidas indicadas en m/m

## TORNILLO CABEZA AVELLANADA ALOMADA CON RANURA SLOTTED RAISED COUNTERSUNK HEAD SCREWS

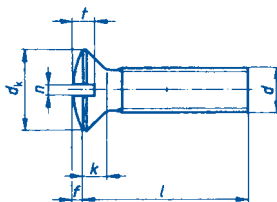

<b>t min.</b>	0,8	1	1,2	1,6	2	2,4	3,2	4
<b>n</b>	0,5	0,6	0,8	1	1,2	1,6	2	2,5
<b>k</b>	1,2	1,5	1,65	2,2	2,5	3	4	5
<b>dk</b>	3,8	4,7	5,6	7,5	9,2	11	14,5	18
<b>f</b>	0,5	0,6	0,75	1	1,2	1,5	2	2,5

<b>d</b>	<b>M-2</b>	<b>M-2,5</b>	<b>M-3</b>	<b>M-4</b>	<b>M-5</b>	<b>M-6</b>	<b>M-8</b>	<b>M-10</b>
<b>L 5</b>	21,94	28,36	16,35					
<b>6</b>	22,98	22,98	11,82	17,64	31,88			
<b>8</b>	24,22	24,22	10,85	16,27	22,98	36,64		
<b>10</b>	26,70	26,70	10,99	13,85	21,94	27,12		
<b>12</b>	28,57	28,57	12,07	14,92	23,81	28,57	111	
<b>14</b>		60,03	19,25	23,18	36,02	40,57		
<b>16</b>	43,06	30,43	13,46	16,56	27,12	31,26	79,90	
<b>18</b>			21,63	25,36	38,30	44,92		
<b>20</b>	57,96	40,37	15,48	18,59	29,81	36,02	88,18	317
<b>25</b>		108	21,32	23,81	35,19	43,06	97,50	366
<b>30</b>			30,63	27,74	37,88	49,27	117	391
<b>35</b>				39,33	55,68	65,62	152	424
<b>40</b>				48,85	62,31	76,59	161	484
<b>45</b>				74,52	78,66	93,56	213	555
<b>50</b>					86,73	117	246	613
<b>60</b>					117	160	311	731
<b>70</b>					183	226	385	874
<b>80</b>					231	279	470	1.029
<b>90</b>						391	582	1.209
<b>100</b>						468	708	1.372

Precios en € por 100 unidades. Medidas indicadas en m/m

## TORNILLO CABEZA AVELLANADA PLANA CON MORTAJA CRUZADA H -PHILLIPS- CROSS RECESSED COUNTERSUNK (FLAT) HEAD SCREWS - H

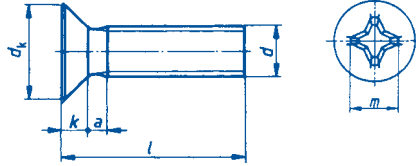

a	0,7	0,8	0,9	1	1,4	1,6	2	2,5	3
k	0,96	1,2	1,5	1,65	2,2	2,5	3	4	5
dk	3	3,8	4,7	5,6	7,5	9,2	11	14,5	18
m	1,7	2,35	2,7	2,9	4,4	4,6	6,6	8,7	9,6

d	M-1,6	M-2	M-2,5	M-3	M-4	M-5	M-6	M-8	M-10
L 4	122	60,03	60,03	51,75					
5	122	49,68	49,68	47,61	53,82				
6	122	49,68	49,68	13,87	19,87	28,77			
8	126	49,68	49,68	13,25	19,46	26,50	53,20		
10	135	49,68	49,68	12,83	16,15	25,46	31,26	165	
12	155	53,82	53,82	14,08	17,39	27,32	32,91	131	
14				23,39	27,95	44,71	52,99		
16		57,96	57,96	15,53	19,46	31,26	36,43	93,36	385
18				26,08	31,26	48,02	57,55		
20		66,24	66,24	18,01	21,74	34,57	41,61	100	294
25				24,43	27,53	40,57	46,58	113	329
30				30,22	33,53	52,16	52,16	134	354
35					45,95	63,55	79,49	175	383
40					56,93	76,80	90,87	187	435
45					88,39	91,91	124	246	507
50					88,39	98,95	134	286	559
60					153	134	184	362	687
70						211	261	447	
80						267	329	546	
90							435	696	
100							522	774	

Precios en € por 100 unidades. Medidas indicadas en m/m

# DIN 966

ACERO INOXIDABLE - STAINLESS STEEL

# A4

aisi 316

## TORNILLO CABEZA AVELLANADA ALOMADA CON MORTAJA CRUZADA H - PHILLIPS- CROSS RECESSED RAISED COUNTERSUNK HEAD SCREWS - H

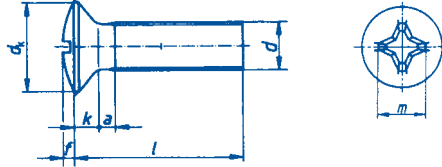

a	0,9	1	1,4	1,6	2	2,5
f	0,6	0,75	1	1,25	1,5	2
k	1,5	1,65	2,2	2,5	3	4
dk	4,7	5,6	7,5	9,2	11	14,5
m	2,7	3,1	4,5	5,3	6,8	9

d	M-2,5	M-3	M-4	M-5	M-6	M-8
L 5	70,38	52,37	59,20			
6	62,10	15,32	21,94	31,67		
8	57,96	14,70	21,32	29,19	58,58	
10	53,82	14,08	17,80	28,15	34,36	182
12	53,82	15,53	19,25	30,02	36,23	144
14		25,88	30,84	49,27	58,37	
16	64,17	17,18	21,53	34,36	40,16	103
18		28,77	34,36	52,79	63,34	
20		19,87	24,01	38,09	45,75	111
25		26,70	30,43	44,71	51,34	124
30		33,33	36,85	52,99	59,82	148
35			50,51	69,97	87,35	192
40			62,72	84,46	99,98	205
45				101	136	271
50			97,50	109	148	315
60				147	203	400
70				232	288	493
80				294	364	602

Precios en € por 100 unidades. Medidas indicadas en m/m

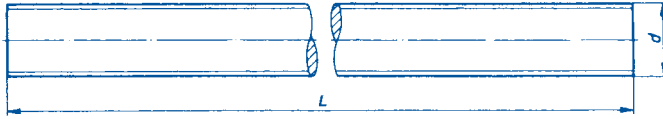
**VARILLA ROSCADA WHITWORTH -UNC-**  
THREADED RODS WHITWORTH -UNC-

d	PRECIO 1 metro
1/4"	3.047
5/16"	3.904
3/8"	6.096
7/16"	9.541
1/2"	10.346
5/8"	20.642
3/4"	26.635
7/8"	36.266
1"	38.866

Precios en € por 100 unidades. Medidas indicadas en m/m



## VARILLA ROSCADA THREADED RODS

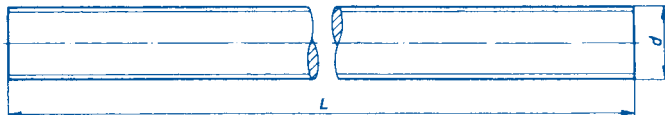

d	PRECIO 1 metro
M-2	1.811
M-2,5	1.811
M-3	801
M-4	549
M-5	515
M-6	658
M-8	1.151
M-10	1.770
M-12	2.565
M-14	3.658
M-16	4.769
M-18	7.222
M-20	8.100
M-22	11.004
M-24	12.646
M-27	18.150
M-30	25.672
M-33	33.375
M-36	43.389
M-39	56.592
M-42	69.757
M-45	77.618

Precios en € por 100 unidades. Medidas indicadas en m/m

## TUERCA AUTOBLOCANTE METALICA FORMA V PREVAILING TORQUE TYPE HEXAGON NUTS, ALL-METAL NUTS

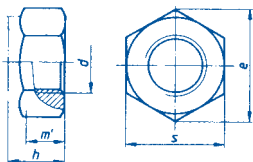

d	s	e	m' min.	h	PRECIO
M-3	5,5	6,01	1,65	3,7	230
M-4	7	7,66	2,2	4,2	238
M-5	8	8,79	2,75	5,1	248
M-6	10	11,05	3,3	6	265
M-8	13	14,38	4,4	8	364
M-10	17	18,9	5,5	10	520
M-12	19	21,1	6,6	12	749
M-16	24	26,75	8,8	16	1.292
M-20	30	32,95	11	20	1.803
M-24	36	39,55	13,2	24	4.736

Precios en € por 100 unidades. Medidas indicadas en m/m

## TUERCA AUTOBLOCANTE FORMA ALTA CON INSERCIÓN NO-METÁLICA

PREVAILING TORQUE TYPE HEXAGON NUTS WITH NON-METALLIC INSERT HIGH TYPE

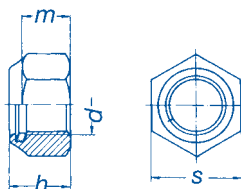

d	s	m min.	h	PRECIO
M-5	8	4,4	6,3	230
M-6	10	4,9	8	230
M-8	13	6,44	9,5	364
M-10	17	8,04	11,5	607
M-12	19	10,37	14	849
M-16	24	14,1	18	1.588
M-20	30	16,9	22	2.960
M-24	36	20,2	28	6.458

Precios en € por 100 unidades. Medidas indicadas en m/m

## TUERCA AUTOBLOCANTE CON INSERCIÓN NO-METALICA PREVAILING TORQUE TYPE HEXAGON NUTS WITH NON METALLIC INSERT, LOW TYPE

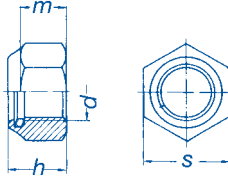

d	s	m min.	h	PRECIO
M-3	5,5	2,4	4	16,25
M-4	7	2,9	5	11,07
M-5	8	3,2	5	11,59
M-6	10	4	6	15,21
M-8	13	5,5	8	31,67
M-10	17	6,5	10	69,14
M-12	19	8	12	102
M-14	22	9,5	14	198
M-16	24	10,5	16	234
M-18	27	13	18,5	1.012
M-20	30	14	20	1.172
M-22	32	15	22	2.263
M-24	36	15	24	3.028
M-27	41	17	27	6.164
M-30	46	19	30	8.247

Precios en € por 100 unidades. Medidas indicadas en m/m



Tel. 93 729 99 60 - Fax 93 729 99 61

**ARANDELA PARA PERNOS**  
 WASHERS FOR CLEVIS PINS, FINISH MEDIUM

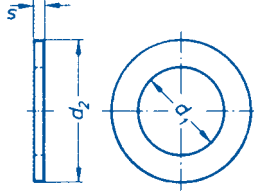

d <sub>1</sub>	d <sub>2</sub>	s	PRECIO
3	6	0,8	89,01
4	8	0,8	89,01
5	10	0,8	93,15
6	12	1,6	124
8	16	2	211
10	20	2,5	311
12	25	3	455
14	28	3	629
16	28	3	644
18	30	4	867
20	32	4	958
22	34	4	1.047
23	36	4	1.155
24	38	4	1.219
25	40	4	1.298
26	40	5	1.501
27	40	5	1.871
28	42	5	2.140
30	45	5	2.679
32	50	5	3.016
33	50	5	3.144
35	52	6	4.010
36	52	6	4.279
40	58	6	4.575

Precios en € por 100 unidades. Medidas indicadas en m/m

**ARANDELA PARA PERNOS**

## WASHERS FOR CLEVIS PINS

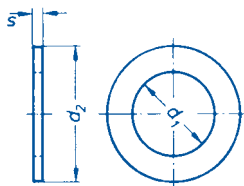

d <sub>1</sub>	d <sub>2</sub>	s	PRECIO
5,5	10	0,8	168
7	12	1,6	190
8	14	1,6	199
9	16	2	232
11	20	2,5	410
13	25	3	482
14	25	3	522
15	28	3	553
17	28	3	582
19	30	4	729
21	32	4	793
23	34	4	847
24	36	4	903
25	38	4	946
26	40	4	1.018
27	40	5	1.263
28	40	5	1.294
29	42	5	1.352
31	45	5	1.437

Precios en € por 100 unidades. Medidas indicadas en m/m

# DIN 1587

ACERO INOXIDABLE - STAINLESS STEEL

# A4

aisi 316

## TUERCA CIEGA FORMA ALTA HEXAGON DOMED CAP NUTS, HIGH TYPE

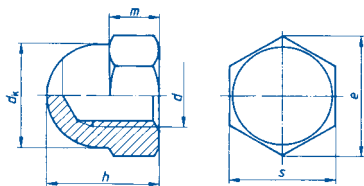

d	s	e	dk max.	m max.	h	PRECIO
M-3	5,5	6,01	5,5	2,4	7	122
M-4	7	7,66	6,5	3,2	8	66,03
M-5	8	8,79	7,5	4	10	69,35
M-6	10	11,05	9,5	5	12	81,14
M-8	13	14,38	12,5	6,5	15	162
M-10	17	18,9	16	8	18	302
M-12	19	21,1	18	10	22	408
M-14	22	24,49	21	11	25	1.399
M-16	24	26,75	23	13	28	1.706
M-18	27	30,14	26	15	32	3.055
M-20	30	33,53	28	16	34	3.148
M-22	34	37,72	33	18	39	7.069
M-24	36	39,98	34	19	42	8.591
M-27	41	47,3	40	20	47	12.755
M-30	46	52	42	24	52	14.666

Precios en € por 100 unidades. Medidas indicadas en m/m

## ARANDELA CÓNICA ELÁSTICA CONICAL SPRING WASHERS FOR BOLTED CONNECTIONS

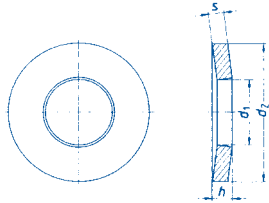

M	d <sub>1</sub>	d <sub>2</sub>	h max.	h min.	s	PRECIO
3	3,2	7	0,85	0,72	0,6	518
4	4,3	9	1,3	1,12	1	546
5	5,3	11	1,55	1,35	1,2	582
6	6,4	14	2	1,7	1,5	590
8	8,4	18	2,6	2,24	2	598
10	10,5	23	3,2	2,8	2,5	869
12	13	29	3,95	3,43	3	1.099
14	15	35	4,65	4,04	3,5	1.604
16	17	39	5,25	4,58	4	1.675
18	19	42	5,8	5,08	4,5	1.906
20	21	45	6,4	5,6	5	2.548
22	23	49	7,05	6,15	5,5	3.939
24	25	56	7,75	6,77	6	4.682

Precios en € por 100 unidades. Medidas indicadas en m/m



## ARANDELA DENTADA FORMA A / ARANDELA DENTADA FORMA J SERRATED LOCK WASHERS FORM A / SERRATED LOCK WASHERS FORM J

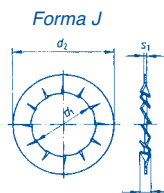
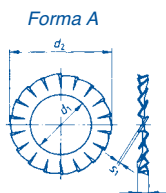

M	d <sub>1</sub>	d <sub>2</sub>	s <sub>1</sub>	6798-A PRECIO	6798-J PRECIO
2	2,2	4,5	0,3	18,42	
2,3	2,5	5	0,4	18,42	
2,5	2,7	5,5	0,4	18,42	
3	3,2	6	0,4	8,69	16,35
4	4,3	8	0,5	8,90	16,97
5	5,3	10	0,6	9,34	17,80
6	6,4	11	0,7	12,83	24,22
7	7,4	12,5	0,8	28,36	54,03
8	8,4	15	0,8	21,53	40,78
10	10,5	18	0,9	34,36	65,21
12	13	20,5	1	58,37	111
14	15	24	1	117	221
16	17	26	1,2	158	300
18	19	30	1,4	246	464
20	21	33	1,4	311	590
22	23	36	1,5	397	756
24	25	38	1,5	470	892
27	28	44	1,6	698	
30	31	48	1,6	919	

Precios en € por 100 unidades. Medidas indicadas en m/m

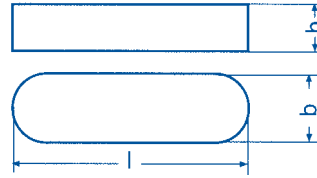
**CHAVETAS DE AJUSTE - FORMA A**  
PARALLEL KEYS

h	4	5	6	7	8	8	9

	h	4	5	6	8	10	12	14
L	12	190						
	16	197	197					
	20	213	213	261	377			
	25		230	288	414			
	30		257	325	472	633	741	
	32			325	472	633	741	
	36			348	503	687	795	
	40			366	542	741	849	983
	45			385	607	795	929	1.064
	50			406	617	861	996	1.145
	60			428	642	1.023	1.199	1.372
	70						1.497	1.722

Precios en € por 100 unidades. Medidas indicadas en m/m



Atar la calidad y el buen servicio es el objetivo principal de nuestra empresa.

## TORNILLO CILÍNDRICO CON EXÁGONO INTERIOR CABEZA BAJA CON GUIA DE LLAVE

SOCKET HEAD CAP SCREWS, LOW HEAD-PILOT RECESS

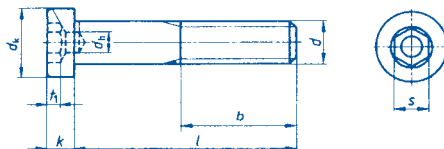

<b>b</b>	14	16	18	22	26	30	38
<b>s</b>	3	4	5	6	8	10	14
<b>k max.</b>	2,8	3,5	4	5	6,5	7,5	10
<b>dk max.</b>	7	8,5	10	13	16	18	24
<b>t<sub>1</sub> min.</b>	1,48	1,88	2,38	2,88	3,35	3,85	5,35

<b>d</b>	<b>M-4</b>	<b>M-5</b>	<b>M-6</b>	<b>M-8</b>	<b>M-10</b>	<b>M-12</b>	<b>M-16</b>
<b>L 6</b>	259						
<b>8</b>	234	294	329				
<b>10</b>	180	197	211	313			
<b>12</b>	180	197	211	313			
<b>16</b>	124	151	166	313	615		
<b>20</b>	130	161	176	257	592	1.033	
<b>25</b>	137	182	199	269	561	867	3.175
<b>30</b>	172	195	207	284	575	903	2.476
<b>35</b>	195	205	221	315	607	958	2.544
<b>40</b>	219	232	253	393	660	1.023	2.625
<b>45</b>		267	302	431	733	1.141	2.745
<b>50</b>		296	346	495	807	1.207	2.906
<b>55</b>			445	530	915	1.372	3.148
<b>60</b>			472	571	969	1.426	3.229
<b>70</b>			607	946	1.099	1.561	3.444
<b>80</b>			789	1.157	1.271	2.314	4.521
<b>90</b>				1.279	1.828	2.664	5.866
<b>100</b>				1.414	2.416	3.283	6.324
<b>110</b>							12.379
<b>120</b>							12.836
<b>130</b>							13.078
<b>140</b>							13.320
<b>150</b>							13.536

Precios en € por 100 unidades. Medidas indicadas en m/m



### TORNILLO ROSCA CHAPA CABEZA CILÍNDRICA FORMA C SLOTTED PAN HEAD TAPPING SCREWS

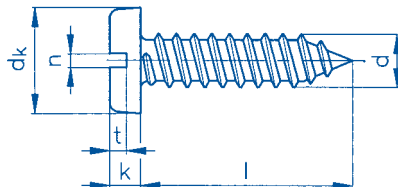

<b>t max.</b>	1	1,25	1,4	1,5	1,7	1,95	2,2
<b>n</b>	0,8	1	1	1,2	1,2	1,6	1,6
<b>k max.</b>	1,75	2,1	2,25	2,45	2,8	3,2	3,65
<b>dk max.</b>	5,6	6,9	7,5	8,2	9,5	10,8	12,5

<b>d</b>	<b>2,9</b>	<b>3,5</b>	<b>3,9</b>	<b>4,2</b>	<b>4,8</b>	<b>5,5</b>	<b>6,3</b>
<b>L n°</b>	<b>4</b>	<b>6</b>	<b>7</b>	<b>8</b>	<b>10</b>	<b>12</b>	<b>14</b>
<b>6,5</b> 1/4"	11,63	15,01	17,33				
<b>9,5</b> 3/8"	10,99	14,22	16,56	18,36	28,59		
<b>13</b> 1/2"	11,63	15,42	17,20	19,40	28,59	42,83	90,56
<b>16</b> 5/8"	12,67	15,92	18,36	21,74	31,69	45,79	90,56
<b>19</b> 3/4"	14,49	17,47	21,74	23,81	34,40	51,63	84,08
<b>22</b> 7/8"	17,33	20,31	24,20	26,12	37,90	55,89	90,56
<b>25</b> 1"	19,79	25,36	27,16	28,46	39,33	60,80	97,02
<b>32</b> 1 1/4"	28,57	28,07	34,03	35,58	44,51	71,15	107
<b>38</b> 1 1/2"		32,60	36,35	42,83	53,94	77,87	123
<b>45</b> 1 3/4"				55,62	73,49	105	201
<b>50</b> 2"				67,15	81,37	115	207
<b>60</b> 2 3/8"				127	138	194	244

Precios en € por 100 unidades. Medidas indicadas en m/m

## TORNILLO ROSCA CHAPA CABEZA AVELLANADA PLANA FORMA C SLOTTED COUNTERSUNK HEAD TAPPING SCREWS

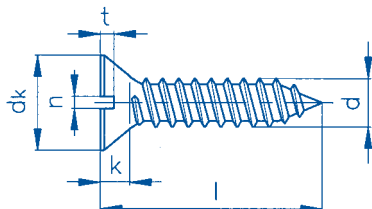

<b>t max.</b>	0,75	0,95	1,05	1,15	1,35	1,5	1,75
<b>n</b>	0,8	1	1	1,2	1,2	1,6	1,6
<b>k max.</b>	1,7	2,1	2,3	2,5	3	3,4	3,8
<b>dk max.</b>	5,5	6,8	7,5	8,1	9,5	10,8	12,4

d	2,9	3,5	3,9	4,2	4,8	5,5	6,3
L n°	4	6	7	8	10	12	14
6,5 1/4"	11,63	15,01	17,33				
9,5 3/8"	10,99	14,22	16,56	18,36	28,59		
13 1/2"	11,63	15,42	17,20	19,40	28,59	42,83	90,56
16 5/8"	12,67	15,92	18,36	21,74	31,69	45,79	90,56
19 3/4"	14,49	17,47	21,74	23,81	34,40	51,63	84,08
22 7/8"	17,33	20,31	24,20	26,12	37,90	55,89	90,56
25 1"	19,79	25,36	27,16	28,46	39,33	60,80	97,02
32 1 1/4"	28,57	28,07	34,03	35,58	44,51	71,15	107
38 1 1/2"		32,60	36,35	42,83	53,94	77,87	123
45 1 3/4"				55,62	73,49	105	201
50 2"				67,15	81,37	115	207
60 2 3/8"				127	138	194	244

Precios en € por 100 unidades. Medidas indicadas en m/m

### TORNILLO ROSCA CHAPA CABEZA AVELLANADA GOTA DE SEBO FORMA C

SLOTTED RAISED COUNTERSUNK HEAD TAPPING SCREWS

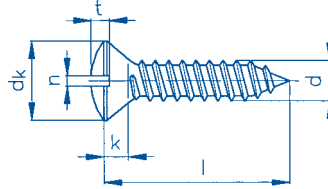

<b>t max.</b>	1,5	1,9	2,05	2,25	2,6	2,95	3,45
<b>n</b>	0,8	1	1	1,2	1,2	1,6	1,6
<b>k max.</b>	1,7	2,1	2,3	2,5	3	3,4	3,8
<b>dk max.</b>	5,5	6,8	7,5	8,1	9,5	10,8	12,4

<b>d</b>	<b>2,9</b>	<b>3,5</b>	<b>3,9</b>	<b>4,2</b>	<b>4,8</b>	<b>5,5</b>	<b>6,3</b>
<b>L n°</b>	<b>4</b>	<b>6</b>	<b>7</b>	<b>8</b>	<b>10</b>	<b>12</b>	<b>14</b>
<b>6,5</b> 1/4"	11,63	15,01	17,33				
<b>9,5</b> 3/8"	10,99	14,22	16,56	18,36	28,59		
<b>13</b> 1/2"	11,63	15,42	17,20	19,40	28,59	42,83	90,56
<b>16</b> 5/8"	12,67	15,92	18,36	21,74	31,69	45,79	90,56
<b>19</b> 3/4"	14,49	17,47	21,74	23,81	34,40	51,63	84,08
<b>22</b> 7/8"	17,33	20,31	24,20	26,12	37,90	55,89	90,56
<b>25</b> 1"	19,79	25,36	27,16	28,46	39,33	60,80	97,02
<b>32</b> 1 1/4"	28,57	28,07	34,03	35,58	44,51	71,15	107
<b>38</b> 1 1/2"		32,60	36,35	42,83	53,94	77,87	123
<b>45</b> 1 3/4"				55,62	73,49	105	201
<b>50</b> 2"				67,15	81,37	115	207
<b>60</b> 2 3/8"				127	138	194	244

Precios en € por 100 unidades. Medidas indicadas en m/m





### TORNILLO ROSCA CHAPA CABEZA CILINDRICA FORMA C - PHILLIPS H CROSS RECESSED PAN HEAD TAPPING SCREWS PHILLIPS H

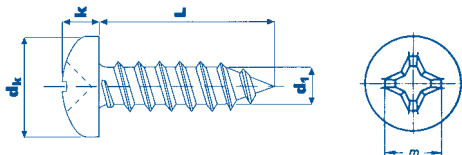

dk	5,6	6,9	7,5	8,2	9,5	10,8	12,5
k max.	2,2	2,6	2,8	3,05	3,55	3,95	4,55
Nr. H	1	2	2	2	2	3	3
m	3	4,2	4,4	4,7	5,1	6,8	7,1

d1	2,9	3,5	3,9	4,2	4,8	5,5	6,3	
L	nº	4	6	7	8	10	12	14
6,5	1/4"	9,03	11,43	13,35				
9,5	3/8"	9,03	11,43	13,35	14,80	24,05		
13	1/2"	9,50	12,28	13,95	14,80	24,05	36,10	73,40
16	5/8"	10,23	12,88	14,90	18,05	26,83	38,63	73,40
19	3/4"	11,78	14,43	18,05	19,85	28,88	41,28	77,00
22	7/8"	13,95	16,60	19,85	21,40	32,00	47,18	85,43
25	1"	15,63	20,93	22,13	26,29	33,20	51,38	92,65
32	1 1/4"	22,30	23,58	28,75	32,15	37,53	60,15	96,28
38	1 1/2"		27,68	30,55	36,33	45,60	65,95	107
45	1 3/4"		41,20	45,30	47,18	62,10	88,58	162
50	2"		48,43	53,60	57,75	69,80	97,48	168
60	2 3/8"				101	117	152	282
70	2 3/4"				165	183	238	441
80	3 1/8"					257	333	617
90	3 1/2"					356	464	859
100	4"					486	633	1.172

Precios en € por 100 unidades. Medidas indicadas en m/m

## TORNILLO ROSCA CHAPA CABEZA AVELLANADA PLANA FORMA C - PHILLIPS H

CROSS RECESSED COUNTERSUNK HEAD TAPPING SCREWS PHILLIPS H

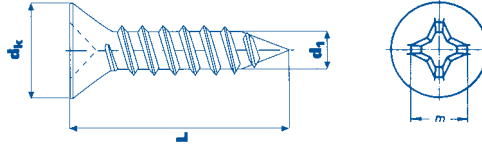

<b>d<sub>k</sub></b>	5,5	6,8	7,5	8,1	9,5	10,8	12,4
<b>k</b>	1,7	2,1	2,3	2,5	3	3,4	3,8
<b>Nr. H</b>	1	2	2	2	2	3	3
<b>m</b>	3	4,2	4,6	4,7	5,1	6,8	7,1

<b>d<sub>1</sub></b>	<b>2,9</b>	<b>3,5</b>	<b>3,9</b>	<b>4,2</b>	<b>4,8</b>	<b>5,5</b>	<b>6,3</b>
<b>L n°</b>	<b>4</b>	<b>6</b>	<b>7</b>	<b>8</b>	<b>10</b>	<b>12</b>	<b>14</b>
<b>6,5 1/4"</b>	9,03	11,43	13,35				
<b>9,5 3/8"</b>	9,03	11,43	13,35	14,80	24,05		
<b>13 1/2"</b>	9,50	12,28	13,95	14,80	24,05	36,10	73,40
<b>16 5/8"</b>	10,23	12,88	14,90	18,05	26,83	38,63	73,40
<b>19 3/4"</b>	11,78	14,43	18,05	19,85	28,88	41,28	77,00
<b>22 7/8"</b>	13,95	16,60	19,85	21,40	32,00	47,18	85,43
<b>25 1"</b>	15,63	20,93	22,13	26,29	33,20	51,38	92,65
<b>32 1 1/4"</b>	22,30	23,58	28,75	32,15	37,53	60,15	96,28
<b>38 1 1/2"</b>		27,68	30,55	36,33	45,60	65,95	107
<b>45 1 3/4"</b>		41,20	45,30	47,18	62,10	88,58	162
<b>50 2"</b>		48,43	53,60	57,75	69,80	97,48	168
<b>60 2 3/8"</b>				101	117	152	282
<b>70 2 3/4"</b>				165	183	238	441
<b>80 3 1/8"</b>					257	333	617
<b>90 3 1/2"</b>					356	464	859
<b>100 4"</b>					486	633	1.172

Precios en € por 100 unidades. Medidas indicadas en m/m



**TORNILLO ROSCA CHAPA CABEZA AVELLANADA  
GOTA DE SEBO FORMA C - PHILLIPS H  
CROSS RECESSED RAISED COUNTERSUNK HEAD TAPPING SCREWS**

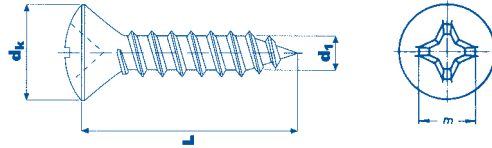

$d_k$	5,5	6,8	7,5	8,1	9,5	10,8	12,4
$K \approx$	1,7	2,1	2,3	2,5	3	3,4	3,8
F	0,9	1,2	1,3	1,4	1,5	1,7	2
Nr. H	1	2	2	2	2	3	3
m	3,4	4,6	4,7	4,9	5,4	7	7,4

$d_1$	2,9	3,5	3,9	4,2	4,8	5,5	6,3	
L	nº	4	6	7	8	10	12	14
6,5	1/4"	9,03	11,43	13,35				
9,5	3/8"	9,03	11,43	13,35	14,80	24,05		
13	1/2"	9,50	12,28	13,95	14,80	24,05	36,10	73,40
16	5/8"	10,23	12,88	14,90	18,05	26,83	38,63	73,40
19	3/4"	11,78	14,43	18,05	19,85	28,88	41,28	77,00
22	7/8"	13,95	16,60	19,85	21,40	32,00	47,18	85,43
25	1"	15,63	20,93	22,13	26,29	33,20	51,38	92,65
32	1 1/4"	22,30	23,58	28,75	32,15	37,53	60,15	96,28
38	1 1/2"		27,68	30,55	36,33	45,60	65,95	107
45	1 3/4"		41,20	45,30	47,18	62,10	88,58	162
50	2"		48,43	53,60	57,75	69,80	97,48	168
60	2 3/8"				101	117	152	282
70	2 3/4"				165	183	238	441
80	3 1/8"					257	333	617
90	3 1/2"					356	464	859
100	4"					486	633	1.172

Precios en € por 100 unidades. Medidas indicadas en m/m

## TORNILLO CILINDRICO CON EXAGONO INTERIOR CABEZA BAJA HEXAGON SOCKET HEAD CAP SCREWS WITH LOW HEAD

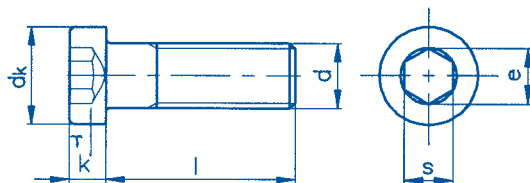

$d_k$	7	8,5	10	13	16	18	24
$k$	2,8	3,5	4	5	6	7	9
$s$	2,5	3	4	5	7	8	12
$t$	2,3	2,7	3	3,8	4,5	5	5,5
$e$	2,87	3,44	4,58	5,72	8,01	9,15	13,72

$d$	M-4	M-5	M-6	M-8	M-10	M-12	M-16
L 6	259						
8	234	294	329				
10	180	197	211	313			
12	180	197	211	313			
16	124	151	166	313	615		
20	130	161	176	257	592	1.033	
25	137	182	199	269	561	867	3.175
30	172	195	207	284	575	903	2.476
35	195	205	221	315	607	958	2.544
40	219	232	253	393	660	1.023	2.625
45			302	431	733	1.141	2.745
50			346	495	807	1.207	2.906
60			472	571	969	1.426	3.229
70				946	1.099	1.561	3.444
80				1.157	1.271	2.314	4.513

Precios en € por 100 unidades. Medidas indicadas en m/m



## TORNILLO CABEZA ALOMADA CON MORTAJA CRUZADA H-PHILLIPS CROSS RECESSED RAISED CHEESE HEAD SCREWS

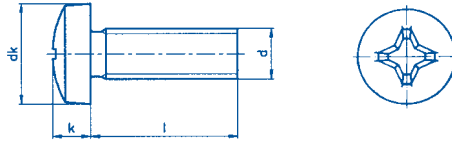

<b>d<sub>k</sub> max.</b>	3,2	4	5	6	8	10	12	16
<b>k</b>	1,3	1,6	2	2,4	3,1	3,8	4,6	6
<b>Nº H</b>	1	1	1	1	2	2	3	4

<b>d</b>	<b>M-1,6</b>	<b>M-2</b>	<b>M-2,5</b>	<b>M-3</b>	<b>M-4</b>	<b>M-5</b>	<b>M-6</b>	<b>M-8</b>
<b>L 4</b>	122	60,03	60,03	62,10				
<b>5</b>	122	49,68	49,68	55,89	64,58			
<b>6</b>	122	49,68	49,68	16,77	24,01	34,57		
<b>8</b>	126	49,68	49,68	15,94	23,39	31,88	63,76	
<b>10</b>	135	49,68	49,68	15,53	19,46	30,64	38,92	
<b>12</b>	155	53,82	53,82	16,97	20,91	32,91	39,54	157
<b>14</b>		70,38	70,38	28,15	33,53	53,61	63,55	
<b>16</b>		57,96	57,96	18,84	23,39	37,47	43,88	112
<b>18</b>		82,80	82,80	31,26	37,47	57,55	69,14	
<b>20</b>		66,24	66,24	21,74	26,08	41,61	50,09	120
<b>25</b>			104	29,39	33,33	48,65	56,10	135
<b>30</b>					40,37	55,27	62,72	161
<b>35</b>					55,27	76,18	95,43	211
<b>40</b>					68,72	92,12	109	226
<b>45</b>						110	149	296
<b>50</b>						119	161	342
<b>60</b>						161	221	435
<b>70</b>						255	313	486
<b>80</b>						321	397	

Precios en € por 100 unidades. Medidas indicadas en m/m

## TORNILLO CABEZA AVELLANADA PLANA CON EXÁGONO INTERIOR HEXAGON SOCKET COUNTERSUNK HEAD SCREWS

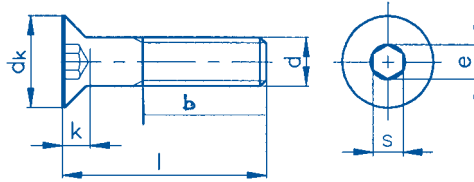

dk	6	8	10	12	16	20	24	30	36
e ≈	2,3	2,9	3,5	4,7	5,8	7	9,4	11,6	13,8
k	1,7	2,3	2,8	3,3	4,4	5,5	6,5	7,5	8,5
s	2	2,5	3	4	5	6	8	10	12
b L ≤ 125	12	14	16	18	22	26	30	38	46
b 125 < L ≤ 200				24	28	32	36	44	52

d	M-3	M-4	M-5	M-6	M-8	M-10	M-12	M-16	M-20
L 6	65,83	65,83							
8	52,79	52,79	71,21	96,88					
10	39,54	39,54	41,81	57,55					
12	39,54	39,54	41,81	57,55	144				
16	41,81	41,81	45,33	58,79	105	219			
20	44,09	46,16	49,27	65,62	113	183	410		
25	48,44	52,58	55,68	81,77	133	228	364	1.658	
30	54,86	60,44	63,76	96,88	145	244	404	1.658	
35		81,56	86,53	113	163	275	441	1.742	
40		93,77	101	126	185	315	503	1.918	2.815
45			121	148	219	371	594	1.991	3.084
50			128	153	250	389	646	2.014	3.281
55				267	333	466	745	2.255	3.505
60			187	284	339	466	745	2.287	3.788
70				391	426	553	884	2.536	4.057
80				503	546	710	1.136	3.252	5.299
90					727	944	1.509	4.025	5.403
100					853	1.110	1.774	4.643	6.044
110						1.499	2.056	7.665	9.884
120						1.844	2.273	8.868	10.723
130								9.998	11.282
140								10.375	11.509
150								11.491	12.668

Precios en € por 100 unidades. Medidas indicadas en m/m

## ARANDELA PLANA

DIÁMETRO EXTERIOR= 3X DIAMETRO NOMINAL DE ROSCA

WASHERS WITH OUTSIDE DIAMETER= 3X NOMINAL THREAD DIAMETER

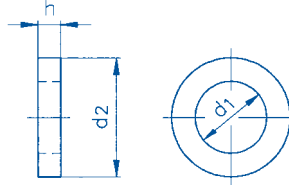

M	d <sub>1</sub>	d <sub>2</sub> max.	h	PRECIO
2	2,2	7	0,8	15,94
2,5	2,7	8	0,8	15,94
3	3,2	9	0,8	5,28
3,5	3,7	11	0,8	9,11
4	4,3	12	1	5,63
5	5,3	15	1,2	9,34
6	6,4	18	1,6	13,25
7	7,4	22	2	55,48
8	8,4	24	2	31,26
10	10,5	30	2,5	57,75
12	13	37	3	125
14	15	44	3	195
16	17	50	3	257
18	19	56	4	776
20	22	60	4	1.026
22	22	60	4	1.026
24	25	72	5	1.799

Precios en € por 100 unidades. Medidas indicadas en m/m



**ARANDELA CÓNICA 90° DECOLLETADA "OVALILLO" NFE 27619**  
ROSETTE TURNED FULL BODY, 90°

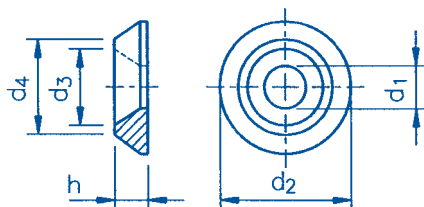

**HX10018**

Para tornillo	d1 min.	d2 max.	d3 min.	h min.	d4	PRECIO
M-3	3,2	10	6,5	1,8	7,3	219
M-4	4,3	14	8,6	2,3	9,5	277
M-5	5,3	16	10,4	2,8	11,5	381
M-6	6,4	18	12,4	3,3	13,5	526
M-8	8,4	25	16,4	4,8	17,5	1.095
M-10	10,5	31	20,4	5,5	21,5	2.043

**ARANDELA CÓNICA 90° EMBUTIDA "OVALILLO" NFE 27619**  
ROSETTE -OPEN MODEL-

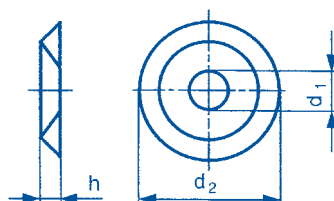

**HX10019**

Para tornillo	d2	d1	h	PRECIO
M-3	9	3,2	1,9	135
M-4	13	4,8	2,7	226
M-5	15	5,5	3,2	304
M-6	17	6,6	3,2	457

Precios en € por 100 unidades. Medidas indicadas en m/m

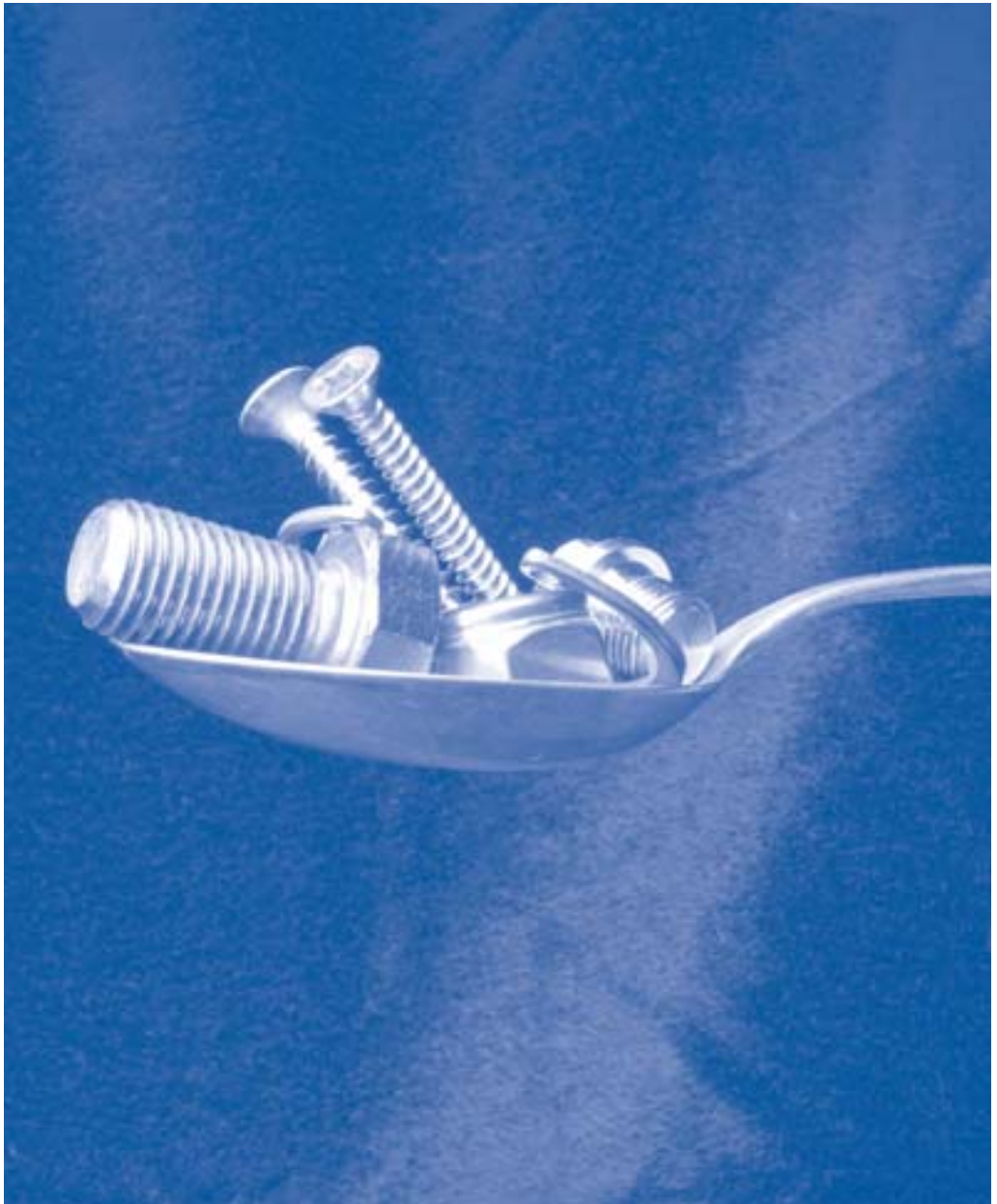

Un excelente equipo de profesionales les ofrece la mejor y más amplia CARTA de productos del mercado.

# DIN 571

ACERO CINCADO - STEEL ZINC PLATED

Zn

## TIRAFONDO CABEZA EXAGONAL HEXAGON HEAD WOOD SCREWS

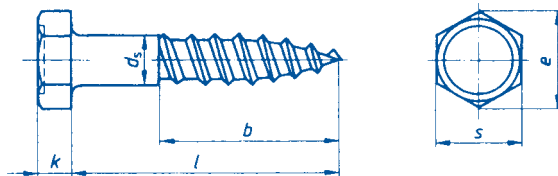

b	b ≥ 0,6 L						
k	3,5	4	5	5,5	7	8	10
e	8,63	10,89	13,07	14,2	18,72	20,88	26,17
s	8	10	12	13	17	19	24

d <sub>s</sub>	5	6	7	8	10	12	16
L 25	3,40	3,60					
30	2,80	3,20	6,50	6,10			
35	3,00	3,50	6,50	6,20			
40	3,20	3,60	6,50	6,40	12,10		
45		4,00	6,70	6,70	12,70		
50	3,60	4,00	6,80	6,90	12,80	23,10	
60	5,00	4,60	7,50	7,80	14,00	24,70	
70		5,20	8,60	8,90	15,80	26,30	
80		5,80	9,50	9,70	17,00	27,90	81,90
90		6,80	11,10	11,20	18,80	31,80	
100		7,50	11,70	11,90	20,70	33,50	85,80
110		13,60	13,60	13,6	24,40	39,70	
120		22,30	15,30	15,30	24,90	41,40	100
130				18,80	30,20	46,90	
140				20,50	34,20	50,20	120
150				22,80	38,50	55,60	
160				85,80	39,70	57,80	140
180				111	126	134	181
200				126	144	155	215

Precios en € por 100 unidades. Medidas indicadas en m/m



Hispanox s.a.

Tel. 93 729 99 60 - Fax 93 729 99 61

**TAPON ROSCADO CON EXAGONO INTERIOR ROSCA CONICA**  
**HEXAGON SOCKET PIPE PLUGS, CONICAL THREAD**

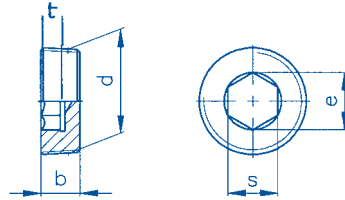

d	b	s	e	t min	PRECIO
M 8x1	8	4	4,6	4	49
M 10x1	8	5	5,7	4	57
M 12x1,5	10	6	6,9	5	66
M 14x1,5	10	7	8	5	81
M 16x1,5	10	8	9,2	5	90
M 18x1,5	10	8	9,2	5	120
M 20x1,5	10	10	11,4	5	132
M 22x1,5	10	10	11,4	5	385
M 24x1,5	12	12	13,7	6	413
M 26x1,5	12	12	13,7	6	1.573
M 30x1,5	12	17	19,4	6	1.372
M 36x1,5	15	19	21,7	7,5	2.407

R 1/8"	8	5	5,7	4	41
R 1/4"	10	7	8	5	45
R 3/8"	10	8	9,2	5	51
R 1/2"	10	10	11,4	5	74
R 5/8"	10	8	9,2	5	119
R 3/4"	12	12	13,7	6	140
R 7/8"	10	10	11,4	5	617
R 1"	12	17	19,4	6	247
R 1 1/4"	18	22	25,2	11,5	3.720
R 1 1/2"	20	24	27,4	11,5	4.250
R 2"	22	32	35,6	17	6.228

NPT 1/16"	6	4	4,6	3	129
NPT 1/8"	8	5	5,7	4	134
NPT 1/4"	10	7	8	4,5	172
NPT 3/8"	10	8	9,2	4,5	201
NPT 1/2"	10	10	11,4	4,5	302
NPT 3/4"	12	12	13,7	5,5	873
NPT 1"	12	17	19,4	6	3.704

Precios en € por 100 unidades. Medidas indicadas en m/m

## TAPON ROSCADO CON EXAGONO INTERIOR ROSCA CONICA HEXAGON SOCKET PIPE PLUGS, CONICAL THREAD

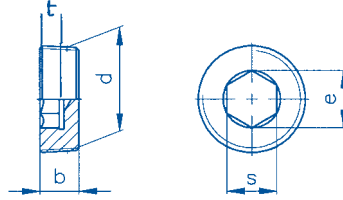

d	b	s	e	t min	PRECIO
R 1/8"	8	5	5,7	4	79
R 1/4"	10	7	8	5	104
R 3/8"	10	8	9,2	5	187
R 1/2"	10	10	11,4	5	285
R 3/4"	12	12	13,7	6	848
R 1"	12	17	19,4	6	1.229

Precios en € por 100 unidades. Medidas indicadas en m/m

**TAPON ROSCADO CON EXAGONO INTERIOR ROSCA PASO FINO**  
**HEXAGON SOCKET SCREW PLUGS, CYLINDRICAL THREAD**

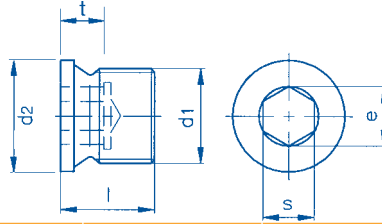

d <sub>1</sub>	d <sub>2</sub>	s	e	L	t min.	PRECIO
M 10x1	14	5	5,7	11	5	73
M 12x1,5	17	6	6,9	15	7	81
M 14x1,5	19	6	6,9	15	7	93
M 16x1,5	21	8	9,2	15	7,5	108
M 18x1,5	23	8	9,2	16	7,5	134
M 20x1,5	25	10	11,4	18	7,5	151
M 22x1,5	27	10	11,4	18	7,5	208
M 24x1,5	29	12	13,7	18	7,5	229
M 26x1,5	31	12	13,7	20	9	347
M 30x1,5	36	17	19,4	20	9	540
M 36x1,5	42	19	21,7	21	10,5	1.740
M 42x1,5	49	22	25,2	21	10,5	5.363
M 48x1,5	55	24	27,4	21	10,5	6.357

G 1/8"	14	5	5,7	11	5	70
G 1/4"	18	6	6,9	15	7	81
G 3/8"	22	8	9,2	15	7,5	105
G 1/2"	26	10	11,4	18	7,5	148
G 5/8"	27	10	11,4	18	7,5	362
G 3/4"	32	12	13,7	20	9	241
G 7/8"	36	17	19,4	20	9	575
G 1"	39	17	19,4	21	9	354
G 1 1/4"	49	22	25,2	21	10,5	2.660
G 1 1/2"	55	24	27,4	21	10,5	3.502
G 2"	68	32	36,6	25	14	5.074
G 1 3/4"	62	32	36,6	25	14	4.765

Precios en € por 100 unidades. Medidas indicadas en m/m

## TAPON ROSCADO CABEZA EXAGONAL ROSCA PASO FINO HEXAGON SOCKET SCREW PLUGS WITH SHOULDER, CYLINDRICAL THREAD

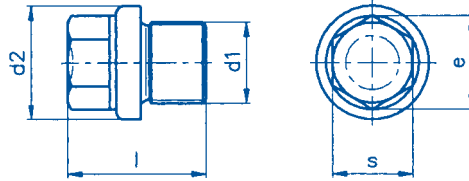

d <sub>1</sub>	d <sub>2</sub>	s	e	L	PRECIO
M 10x1	14	10	10,89	17	138
M 12x1,5	17	13	14,2	21	151
M 14x1,5	19	13	14,2	21	189
M 16x1,5	21	17	18,72	21	222
M 18x1,5	23	17	18,72	24	259
M 20x1,5	25	19	20,88	26	298
M 22x1,5	27	19	20,88	26	377
M 24x1,5	29	22	23,91	27	416
M 26x1,5	31	24	26,17	30	656
M 30x1,5	36	24	26,17	30	777
M 36x1,5	42	27	29,56	32	1.996
M 42x1,5	49	30	32,95	33	6.690
M 48x1,5	55	30	32,95	33	8.035

G 1/8"	14	10	10,89	17	140
G 1/4"	18	13	14,2	21	151
G 3/8"	22	17	18,72	21	184
G 1/2"	26	19	20,88	26	217
G 5/8"	28	19	21,9	26	707
G 3/4"	32	24	26,17	30	364
G 7/8"	36	24	26,17	30	740
G 1"	39	27	29,56	32	616
G 1 1/4"	49	30	32,95	33	3.967
G 1 1/2"	55	30	32,95	33	5.515
G 13/4"	62	36	39,55	40	7.507
G 2"	65	36	39,55	40	7.994

Precios en € por 100 unidades. Medidas indicadas en m/m

**LLAVE ALLEN - HEXAGON KEY**

ACERO CROMO VANADIO PAVONADO

**DIN 911**

S	Cont. caja	PRECIO
0,9	25	118
1,3	25	118
1,5	50	13
2	50	14
2,5	50	17
3	50	19
4	50	23
5	50	26
6	50	37
7	25	70
8	25	76
9	10	140
10	10	148
12	10	316
14	10	413
17	5	648
19	5	831

**POSICIONADOR DE BOLA Y MUELLE**

CALIDAD 8,8 PAVONADO

**HX 10066**

D	Presión Kgr.	Cont. caja	PRECIO
M4	0,4 - 1	100	151
M5	0,6 - 1,1	100	162
M6	0,9 - 1,3	100	172
M8	1,5 - 3	100	181
M10	2 - 3,5	100	229
M12	3 - 5,5	50	320
M14	5 - 9	50	368
M16	6,5 - 12,5	50	447

Precios en € por 100 unidades. Medidas indicadas en m/m



## ESPARRAGO ROSCADO CON EXAGONO INTERIOR PUNTA PLANA HEXAGON SOCKET SET SCREWS WITH FLAT POINT

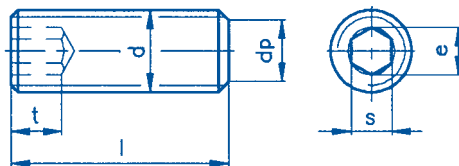

$d_p$ max.	1	1,5	2	2,5	3,5	4	5,5	7	8,5	10	12	13	15	17	18	23
t min.	0,8	1,2	1,2	1,5	2	2	3	4	4,8	5,5	6,4	7,2	8	9,5	11	14
e	1	1,42	1,73	2,3	2,87	3,44	4,58	5,72	6,86	6,86	9,15	11,43	11,43	13,72	13,72	16,2
s	0,9	1,3	1,5	2	2,5	3	4	5	6	6	8	10	10	12	12	14

d	2	2,5	3	4	5	6	8	10	12	14	16	18	20	22	24	30
L 2	18,2															
2,5	18,2	14,1	8,8													
3	15,9	14,1	2,1	3,5												
4	16,4	11,6	1,9	1,8	4,2	15,6										
5	16,9	12,1	2,0	1,6	1,7	4,9										
6	17,5	12,6	2,1	1,7	1,8	1,9	7,0									
8	18,4	13,2	2,2	1,8	1,9	2,0	2,6	11,6								
10	19,7	13,9	2,4	2,0	2,2	2,3	3,0	4,7	15,9	106						
12	21,1	14,9	2,7	2,2	2,4	2,6	3,5	5,1	7,4	63,6	91,4					
14			8,5	5,9	6,3	6,7	11,7	14,8	19,9	81,5	91,4					
16			3,8	2,7	3,1	3,3	4,8	6,8	9,3	34,1	19,7		347			
20			6,2	3,6	3,9	4,3	5,9	8,1	11,7	39,3	23,8	231	139	511	409	
25			8,9	5,5	4,6	5,4	7,5	9,6	15,3	48,5	29,4	256	150	478	382	1.742
30			15,7	8,7	6,1	6,7	9,4	11,7	18,7	61,1	34,5	279	159	492	394	1.818
35				13,8	8,1	8,6	14,2	15,1	24,9	72,5	43,4	310	174	515	412	1.875
40				15,9	8,9	9,5	17,6	18,5	28,2	83,2	49,5	338	186	532	426	1.931
45					26,4	12,9	24,1	27,7	34,2	96,5	63,7	374	203	591	474	1.990
50					26,4	14,7	26,6	30,6	37,8	101	67,1	396	215	638	510	2.082
55						48,4	41,0	47,2	54,3	121	86,4	461	266	752	602	
60						48,4	41,0	47,2	54,4	121	86,4	461	266	752	602	2.460
70						91,4	57,6	66,2	76,2	153	99,0	522	315	871	697	2.577
80						122	75,0	83,5	97,1	194	112	620	368	990	793	2.691
90						168	98,6	128	145	230	145	707	416	1.115	893	2.842
100							121	151	180	252	163	784	461	1.233	988	3.219

Precios en € por 100 unidades. Medidas indicadas en m/m

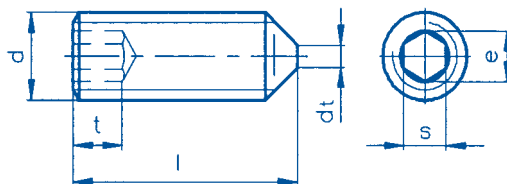

**ESPARRAGO ROSCADO CON EXAGONO INTERIOR PUNTA CÓNICA**  
**HEXAGON SOCKET SET SCREWS WITH CONE POINT**

d: max.	-	-	0,4	0,5	1	1,5	2	2,5	3	4	4	5	6
t min.	0,8	1,2	1,2	1,5	2	2	3	4	4,8	5,5	6,4	8	11
e	1,00	1,42	1,73	2,3	2,87	3,48	4,58	5,72	6,86	6,86	9,15	11,43	13,72
s	0,9	1,3	1,5	2	2,5	3	4	5	6	6	8	10	12

d	2	2,5	3	4	5	6	8	10	12	14	16	20	24
L 2	40,1												
2,5	40,1	31,1											
3	35,1	31,1	6,3	7,6									
4	36,0	25,6	4,9	3,6	10,0	14,9							
5	37,1	26,6	5,1	3,2	4,1	12,6							
6	38,4	27,6	5,5	3,5	3,7	4,9	15,5						
8	40,5	29,0	5,8	3,7	3,9	4,2	7,3	27,9					
10	43,4	30,5	6,6	3,9	4,2	4,4	6,7	14,0	46,4				
12		32,7	7,3	4,4	4,6	4,9	7,5	12,1	23,6				
14			18,6	13,4	14,2	15,5	18,4	23,5	49,3	135	127		
16			9,8	5,2	5,4	5,8	8,6	14,3	20,8	81,4	67,9		
20			12,3	6,5	6,9	7,4	10,3	16,9	27,4	85,7	71,4	163	
25			18,1	9,6	8,7	9,3	13,7	20,6	31,8	94,3	78,6	170	432
30			26,9	13,9	11,8	12,7	17,6	24,6	35,5	104	85,7	179	446
35				19,7	14,9	15,5	21,4	33,6	41,8	114	93,6	195	466
40				25,3	21,5	18,1	28,2	38,6	47,3	123	101	208	482
45					27,9	24,7	35,2	44,3	63,4	156	122	229	536
50					32,7	29,1	41,9	51,4	68,7	175	131	243	576
55						45,3	61,6	80,7	93,6	208	162	299	681
60						45,3	61,6	80,7	93,6	208	162	299	681
70							89,3	106	123	244	198	354	789
80							109	122	156	299	243	429	895
90							141	159	189	368	298	507	1.009
100							163	176	222	409	337	553	1.117

Precios en € por 100 unidades. Medidas indicadas en m/m

## ESPARRAGO ROSCADO CON EXAGONO INTERIOR PUNTA PIVOTE HEXAGON SOCKET SET SCREWS WITH DOG POINT

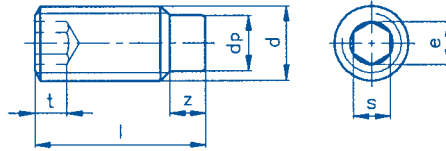

$d_p$ max.	1	1,5	2	2,5	3,5	4	5,5	7	8,5	10	12	15	18
t min.	0,8	1,2	1,2	1,5	2	2	3	4	4,8	5,5	6,4	8	11
e	1,00	1,42	1,73	2,3	2,87	3,44	4,58	5,72	6,86	6,86	9,15	11,43	13,72
s	0,9	1,3	1,5	2	2,5	3	4	5	6	6	8	10	12

d	2	2,5	3	4	5	6	8	10	12	14	16	20	24
L 2	25,5												
2,5	25,5	20,0											
3	24,3	20,0	7,0										
4	25,0	17,9	6,3	8,6									
5	25,7	18,6	6,5	6,3	9,7								
6	26,4	19,3	6,9	6,5	7,2	10,3							
8	29,3	20,0	7,7	6,8	7,5	7,9	14,5						
10	33,6	20,7	8,5	7,4	7,8	8,1	12,6	23,6					
12		22,1	9,4	7,8	8,1	8,5	13,1	17,1	38,2				
14			18,0	19,1	19,9	20,6	25,7	36,7	49,3				
16			11,8	9,8	10,4	10,9	14,1	17,2	26,9	67,9	58,9		
20			14,4	12,1	12,8	13,5	17,5	21,4	30,2	75,0	62,2	174	
25			17,2	15,1	16,1	17,1	21,3	26,1	35,1	83,6	68,0	180	465
30			19,8	17,8	18,9	19,9	24,8	30,3	39,6	94,3	74,9	191	480
35				20,7	21,9	23,3	28,9	35,3	45,0	115	84,3	208	502
40				25,7	27,2	28,9	33,5	40,9	49,3	131	93,6	224	531
45					35,1	37,3	40,3	49,3	62,1	145	104	244	577
50					42,5	45,1	48,7	59,5	72,1	161	112	259	621
55						62,1	70,0	81,1	90,0	219	135	321	733
60						62,1	70,0	81,1	90,0	219	135	321	733
70						114	99,3	111	118	258	170	384	849
80						197	126	136	146	294	223	457	964
90							173	193	210	349	264	536	1.087
100							197	239	241	384	315	592	1.203

Precios en € por 100 unidades. Medidas indicadas en m/m

**ESPARRAGO ROSCADO CON EXAGONO INTERIOR**  
**PUNTA CON CHAFLAN Y CONO INTERNO**  
 HEXAGON SOCKET SET SCREWS WITH CUP POINT

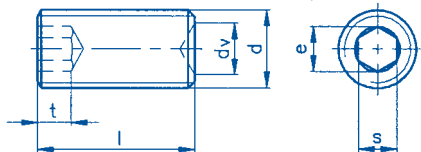

<b>d<sub>v</sub> max.</b>	1	1,2	1,4	2	2,5	3	5	6	8	9	10	12	14	16	16
<b>t min.</b>	0,8	1,2	1,2	1,5	2	2	3	4	4,8	5,5	6,4	7,2	8	9,5	11
<b>e</b>	1,00	1,42	1,73	2,3	2,87	3,44	4,58	5,72	6,86	6,86	9,15	11,43	11,43	13,72	13,72
<b>s</b>	0,9	1,3	1,5	2	2,5	3	4	5	6	6	8	10	10	12	12

<b>d</b>	2	2,5	3	4	5	6	8	10	12	14	16	18	20	22	24
<b>L 2</b>	21,5														
<b>2,5</b>	21,5	16,6	10,4												
<b>3</b>	18,8	16,6	2,5	4,1											
<b>4</b>	19,4	13,7	2,2	2,1	5,0	18,4									
<b>5</b>	19,9	14,3	2,4	1,9	2,0	5,8									
<b>6</b>	20,7	14,9	2,5	2,0	2,1	2,2	8,3								
<b>8</b>	21,7	15,6	2,6	2,1	2,2	2,4	3,1	13,7							
<b>10</b>	23,2	16,4	2,7	2,4	2,6	2,7	3,5	5,5	18,8	125					
<b>12</b>	24,9	17,6	3,2	2,6	2,8	3,1	4,1	6,0	8,7	75,0	108				
<b>14</b>			10,0	7,1	7,4	7,9	13,8	17,5	23,5	96,2	108				
<b>16</b>			4,5	3,2	3,7	3,9	5,7	8,0	11,0	40,2	23,2		409		
<b>20</b>			7,3	4,2	4,6	5,1	7,0	9,6	13,8	46,4	28,1	273	164	603	483
<b>25</b>			10,5	6,5	5,4	6,4	8,9	11,3	18,1	57,2	34,7	302	177	564	451
<b>30</b>			18,5	10,3	7,2	7,9	11,1	13,8	22,1	72,1	40,7	329	188	581	465
<b>35</b>				16,3	9,6	10,2	16,8	17,8	29,4	85,6	51,2	366	205	608	486
<b>40</b>				18,8	10,5	11,2	20,8	21,8	33,3	98,2	58,4	399	219	628	503
<b>45</b>					31,2	15,2	28,4	32,7	40,4	114	75,2	441	240	697	559
<b>50</b>					31,2	17,3	31,4	36,2	44,6	119	79,2	467	254	753	602
<b>55</b>						57,1	48,4	55,7	64,1	143	102	544	314	887	710
<b>60</b>						57,1	48,4	55,7	64,1	143	102	544	314	887	710
<b>70</b>						108	68,0	78,2	90,3	181	117	616	372	1.028	822
<b>80</b>						144	88,5	98,6	115	229	132	732	434	1.168	936
<b>90</b>						198	116	151	171	271	171	835	491	1.316	1.054
<b>100</b>							143	178	212	297	192	926	544	1.455	1.166

Precios en € por 100 unidades. Medidas indicadas en m/m

## ANILLO DE SEGURIDAD EXTERIOR RETAINING RINGS FOR SHAFTS

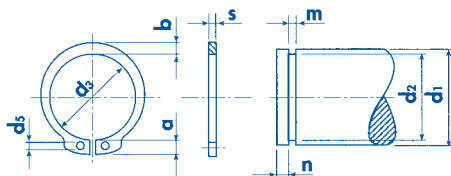

Medida Nominal Ø EJE D1	anillo de seguridad					Ranura alojamiento anillo			
	s	d <sub>s</sub>	d <sub>2</sub>	b ≈	a max.	d <sub>2</sub>	m (H13)	n (min.)	PRECIO
4	0,4	1	3,7	0,9	2,2	3,8	0,5	0,3	0,53
5	0,6	1	4,7	1,1	2,5	4,8	0,7	0,3	0,57
6	0,7	1,2	5,6	1,3	2,7	5,7	0,8	0,5	0,64
7	0,8	1,2	6,5	1,4	3,1	6,7	0,9	0,5	0,80
8	0,8	1,2	7,4	1,5	3,2	7,6	0,9	0,6	0,82
9	1	1,2	8,4	1,7	3,3	8,6	1,1	0,6	0,96
10	1	1,5	9,3	1,8	3,3	9,6	1,1	0,6	1,02
11	1	1,5	10,2	1,8	3,3	10,5	1,1	0,8	1,10
12	1	1,7	11	1,8	3,3	11,5	1,1	0,8	1,14
13	1	1,7	11,9	2	3,4	12,4	1,1	0,9	1,44
14	1	1,7	12,9	2,1	3,5	13,4	1,1	0,9	1,52
15	1	1,7	13,8	2,2	3,6	14,3	1,1	1,1	1,67
16	1	1,7	14,7	2,2	3,7	15,2	1,1	1,2	1,96
17	1	1,7	15,7	2,3	3,8	16,2	1,1	1,2	2,10
18	1,2	2	16,5	2,4	3,9	17	1,3	1,5	2,54
19	1,2	2	17,5	2,5	3,9	18	1,3	1,5	2,90
20	1,2	2	18,5	2,6	4	19	1,3	1,5	3,05
21	1,2	2	19,5	2,7	4,1	20	1,3	1,5	3,48
22	1,2	2	20,5	2,8	4,2	21	1,3	1,5	3,63
23	1,2	2	21,5	2,9	4,3	22	1,3	1,5	4,13
24	1,2	2	22,2	3	4,4	22,9	1,3	1,7	4,22
25	1,2	2	23,2	3	4,4	23,9	1,3	1,7	4,42
26	1,2	2	24,2	3,1	4,5	24,9	1,3	1,7	5,08
28	1,5	2	25,9	3,2	4,7	26,6	1,6	2,1	5,80
29	1,5	2	26,9	3,4	4,8	27,6	1,6	2,1	6,09
30	1,5	2	27,9	3,5	5	28,6	1,6	2,1	6,30
31	1,5	2,5	28,6	3,6	5,2	29,3	1,6	2,6	8,30
32	1,5	2,5	29,6	3,6	5,2	30,3	1,6	2,6	8,60

Precios en € por 100 unidades. Medidas indicadas en m/m

### ANILLO DE SEGURIDAD EXTERIOR RETAINING RINGS FOR SHAFTS

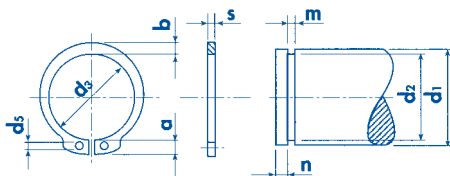

Medida Nominal Ø EJE D1	anillo de seguridad					Ranura alojamiento anillo			
	s	d <sub>5</sub>	d <sub>3</sub>	b ≈	a max.	d <sub>2</sub>	m (H13)	n (min.)	PRECIO
34	1,5	2,5	31,5	3,8	5,4	32,3	1,6	2,6	8,80
35	1,5	2,5	32,2	3,9	5,6	33	1,6	3	9,20
36	1,75	2,5	33,2	4	5,6	34	1,85	3	10,60
38	1,75	2,5	35,2	4,2	5,9	36	1,85	3	11,30
40	1,75	2,5	36,5	4,4	6	37,5	1,85	3,8	11,60
42	1,75	2,5	38,5	4,5	6,5	39,5	1,85	3,8	14,20
44	1,75	2,5	40,5	4,6	6,6	41,5	1,85	3,8	15,50
45	1,75	2,5	41,5	4,7	6,7	42,5	1,85	3,8	15,50
46	1,75	2,5	42,5	4,8	6,7	43,5	1,85	3,8	16,90
47	1,75	2,5	43,5	4,9	6,8	44,5	1,85	3,8	16,90
48	1,75	2,5	44,5	5,	6,9	45,5	1,85	3,8	17,20
50	2	2,5	45,8	5,1	6,9	47	2,15	4,5	17,20
52	2	2,5	47,8	5,2	7	49	2,15	4,5	18,50
55	2	2,5	50,8	5,4	7,2	52	2,15	4,5	19,80
56	2	2,5	51,8	5,5	7,3	53	2,15	4,5	22,50
58	2	2,5	53,8	5,6	7,3	55	2,15	4,5	23,10
60	2	2,5	55,8	5,8	7,4	57	2,15	4,5	23,10
62	2	2,5	57,8	6	7,5	59	2,15	4,5	24,80
63	2	2,5	58,8	6,2	7,6	60	2,15	4,5	25,40
65	2,5	3	60,8	6,3	7,8	62	2,65	4,5	29,70
68	2,5	3	63,5	6,5	8	65	2,65	4,5	34,40
70	2,5	3	65,5	6,6	8,1	67	2,65	4,5	34,40
75	2,5	3	70,5	7	8,4	72	2,65	4,5	35,80
80	2,5	3	74,5	7,4	8,6	76,5	2,65	5,3	38,50
85	3	3,5	79,5	7,8	8,7	81,5	3,15	5,3	49,30
90	3	3,5	84,5	8,2	8,8	86,5	3,15	5,3	58,10
95	3	3,5	89,5	8,6	9,4	91,5	3,15	5,3	66,70
100	3	3,5	94,5	9	9,6	96,5	3,15	5,3	68,20
105	4	3,5	98	9,3	9,9	101	4,15	6	149

Precios en € por 100 unidades. Medidas indicadas en m/m

# DIN 471

ACERO PARA MUELLES - STEEL

## ANILLO DE SEGURIDAD EXTERIOR RETAINING RINGS FOR SHAFTS

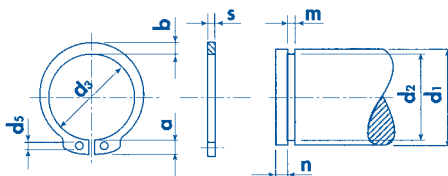

Medida Nominal	anillo de seguridad					Ranura alojamiento anillo			
	Ø EJE D1	s	d <sub>5</sub>	d <sub>3</sub>	b ≈	a max.	d <sub>2</sub>	m (H13)	n (min.)
110	4	3,5	103	9,6	10,1	106	4,15	6	162
115	4	3,5	108	9,8	10,6	111	4,15	6	179
120	4	3,5	113	10,2	11	116	4,15	6	182
125	4	4	118	10,4	11,4	121	4,15	6	191
130	4	4	123	10,7	11,6	126	4,15	6	196
135	4	4	128	11	11,8	131	4,15	6	217
140	4	4	133	11,2	12	136	4,15	6	222
145	4	4	138	11,5	12,2	141	4,15	6	248
150	4	4	142	11,8	13	145	4,15	7,5	264

Precios en € por 100 unidades. Medidas indicadas en m/m



## ANILLO DE SEGURIDAD INTERIOR RETAINING RINGS FOR BORES

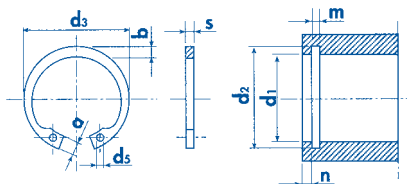

Medida Nominal Ø AGUJERO D1	anillo de seguridad					Ranura alojamiento anillo			
	s	d <sub>5</sub>	d <sub>3</sub>	b ≈	a max.	d <sub>2</sub>	m (H13)	n (min.)	PRECIO
8	0,8	1	8,7	1,1	2,4	8,4	0,9	0,6	0,92
9	0,8	1	9,8	1,3	2,5	9,4	0,9	0,6	0,92
10	1	1,2	10,8	1,4	3,2	10,4	1,1	0,6	1,00
11	1	1,2	11,8	1,5	3,3	11,4	1,1	0,6	1,00
12	1	1,5	13	1,7	3,4	12,5	1,1	0,8	1,03
13	1	1,5	14,1	1,8	3,6	13,6	1,1	0,9	1,03
14	1	1,7	15,1	1,9	3,7	14,6	1,1	0,9	1,17
15	1	1,7	16,2	2	3,7	15,7	1,1	1,1	1,17
16	1	1,7	17,3	2	3,8	16,8	1,1	1,2	1,34
17	1	1,7	18,3	2,1	3,9	17,8	1,1	1,2	1,52
18	1	2	19,5	2,2	4,1	19	1,1	1,5	1,70
19	1	2	20,5	2,2	4,1	20	1,1	1,5	1,80
20	1	2	21,5	2,3	4,2	21	1,1	1,5	1,85
21	1	2	22,5	2,4	4,2	22	1,1	1,5	2,20
22	1	2	23,5	2,5	4,2	23	1,1	1,5	2,35
23	1,2	2	24,6	2,5	4,2	24	1,3	1,7	3,00
24	1,2	2	25,9	2,6	4,4	25,2	1,3	1,8	3,30
25	1,2	2	26,9	2,7	4,5	26,2	1,3	1,8	3,50
26	1,2	2	27,9	2,8	4,7	27,2	1,3	1,8	3,84
27	1,2	2	29,9	2,9	4,7	28,2	1,3	1,8	4,20
28	1,2	2	30,1	2,9	4,8	29,4	1,3	2,1	4,53
29	1,2	2	31,1	3	4,8	30,4	1,3	2,1	4,84
30	1,2	2	32,1	3	4,8	31,4	1,3	2,1	5,22
31	1,2	2,5	33,4	3,2	5,2	32,7	1,3	2,6	5,40
32	1,2	2,5	34,4	3,2	5,2	33,7	1,3	2,6	5,55
34	1,5	2,5	36,5	3,3	5,4	35,7	1,6	2,6	6,90
35	1,5	2,5	37,8	3,3	5,4	37	1,6	3	7,10
36	1,5	2,5	38,8	3,5	5,4	38	1,6	3	7,50

Precios en € por 100 unidades. Medidas indicadas en m/m



### ANILLO DE SEGURIDAD INTERIOR RETAINING RINGS FOR BORES

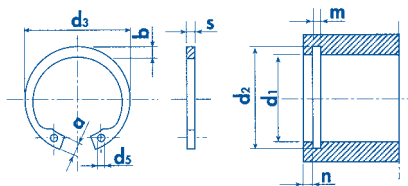

Medida nominal Ø AGUJERO D1	Anillo de seguridad					Ranura alojamiento anillo			
	s	d <sub>5</sub>	d <sub>3</sub>	b ≈	a max.	d <sub>2</sub>	m (H13)	n (min.)	PRECIO
37	1,5	2,5	39,8	3,6	5,5	39	1,6	3	8,30
38	1,5	2,5	40,8	3,7	5,5	40	1,6	3	8,60
40	1,75	2,5	43,5	4	5,9	42,5	1,85	3,8	10,40
42	1,75	2,5	45,5	4,1	5,9	44,5	1,85	3,8	11,60
44	1,75	2,5	47,5	4,2	6	46,5	1,85	3,8	12,40
45	1,75	2,5	48,5	4,3	6,2	47,5	1,85	3,8	12,90
46	1,75	2,5	49,5	4,4	6,3	48,5	1,85	3,8	13,20
47	1,75	2,5	50,5	4,4	6,4	49,5	1,85	3,8	13,70
48	1,75	2,5	51,5	4,5	6,4	50,5	1,85	3,8	14,10
50	2	2,5	54,2	4,6	6,5	53	2,15	4,5	14,40
52	2	2,5	56,2	4,7	6,7	55	2,15	4,5	14,70
55	2	2,5	59,2	5	6,8	58	2,15	4,5	15,90
56	2	2,5	60,2	5,1	6,8	59	2,15	4,5	17,70
58	2	2,5	62,2	5,2	6,9	61	2,15	4,5	18,60
60	2	2,5	64,2	5,4	7,3	63	2,15	4,5	19,10
62	2	2,5	66,2	5,5	7,3	65	2,15	4,5	19,80
63	2	2,5	67,2	5,6	7,3	66	2,15	4,5	20,50
65	2,5	3	69,2	5,8	7,6	68	2,65	4,5	25,30
68	2,5	3	72,5	6,1	7,8	71	2,65	4,5	28,60
70	2,5	3	74,5	6,2	7,8	73	2,65	4,5	29,10
72	2,5	3	76,5	6,4	7,8	75	2,65	4,5	29,40
75	2,5	3	79,5	6,6	7,8	78	2,65	4,5	29,90
78	2,5	3	82,5	6,8	8,5	81	2,65	4,5	31,90
80	2,5	3	85,5	7	8,5	83,5	2,65	5,3	32,40
85	3	3,5	90,5	7,2	8,6	88,5	3,15	5,3	41,50
90	3	3,5	95,5	7,6	8,6	93,5	3,15	5,3	43,10
95	3	3,5	100,5	8,1	8,8	98,5	3,15	5,3	47,70
100	3	3,5	105,5	8,4	9,2	103,5	3,15	5,3	50,80

Precios en € por 100 unidades. Medidas indicadas en mm



## ANILLO DE SEGURIDAD INTERIOR RETAINING RINGS FOR BORES

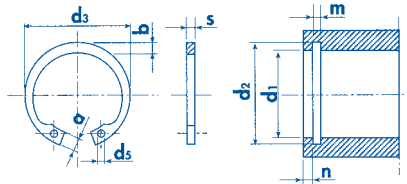

Medida Nominal Ø AGUJERO D1	anillo de seguridad					Ranura alojamiento anillo			
	s	d <sub>5</sub>	d <sub>3</sub>	b ≈	a max.	d <sub>2</sub>	m (H13)	n (min.)	PRECIO
105	4	3,5	112	8,7	9,5	109	4,15	6	93,80
110	4	3,5	117	9	10,4	114	4,15	6	101
115	4	3,5	122	9,3	10,5	119	4,15	6	109
120	4	3,5	127	9,7	11	124	4,15	6	112
125	4	4	132	10	11	129	4,15	6	121
130	4	4	137	10,2	11	134	4,15	6	129
135	4	4	142	10,5	11,2	139	4,15	6	141
140	4	4	147	10,7	11,2	144	4,15	6	147
145	4	4	152	10,9	11,4	149	4,15	6	164
150	4	4	158	11,2	12	155	4,15	6	186

Precios en € por 100 unidades. Medidas indicadas en m/m

### ANILLO DE SEGURIDAD PARA EJES RETAINING WASHERS FOR SHAFTS

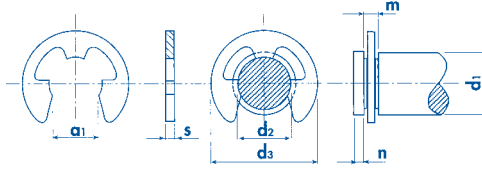

d <sub>2</sub>	d <sub>1</sub>		n min.	m	d <sub>3</sub> max.	S	a <sub>1</sub>	PRECIO
	de	hasta						
1,2	1,4	2	0,6	0,34	3,25	0,3	1,01	0,40
1,5	2	2,5	0,8	0,44	4,25	0,4	1,28	0,30
1,9	2,5	3	1	0,54	4,8	0,5	1,61	0,30
2,3	3	4	1	0,64	6,3	0,6	1,94	0,31
3,2	4	5	1	0,64	7,3	0,6	2,7	0,33
4	5	7	1,2	0,74	9,3	0,7	3,34	0,42
5	6	8	1,2	0,74	11,3	0,7	4,11	0,55
6	7	9	1,2	0,74	12,3	0,7	5,26	0,68
7	8	11	1,5	0,94	14,3	0,9	5,84	0,99
8	9	12	1,8	1,05	16,3	1	6,52	1,26
9	10	14	2	1,15	18,8	1,1	7,63	1,60
10	11	15	2	1,25	20,4	1,2	8,32	2,06
12	13	18	2,5	1,35	23,4	1,3	10,45	2,84
15	16	24	3	1,55	29,4	1,5	12,61	6,16
19	20	31	3,5	1,80	37,6	1,75	15,92	9,20
24	25	38	4	2,05	44,6	2	21,88	14,10

Precios en € por 100 unidades. Medidas indicadas en m/m



# CONDICIONES GENERALES DE VENTA

## **PRECIOS**

Los precios que figuran en este catálogo no incluyen el I.V.A.

## **PORTES**

Los pedidos de importe superior a 600 € se enviarán a portes pagados, a través de nuestra agencia de transporte (sólo península y Baleares).

## **CANTIDAD MÍNIMA**

La cantidad mínima de un artículo deberá superar un importe neto de 3 €.

## **DEVOLUCIONES**

No se aceptarán devoluciones de material por motivos no imputables a HISPANOX.

Si excepcionalmente se aceptara una devolución esta se hará en las condiciones siguientes:

- 1- Que dichos artículos sean de stock habitual.
- 2- Que la devolución sea aceptada previamente y de forma expresa por HISPANOX y que sea enviada a portes PAGADOS.
- 3- Se abonará el artículo al precio facturado en su día con una depreciación del 15% en concepto de gastos de recepción y manipulación.

## **RESPONSABILIDAD**

Las reparaciones o sustituciones de piezas defectuosas deberán efectuarse o autorizarse por Hispanox y en ningún caso el cliente podrá pretender cargos ni reclamar daños y perjuicios por tales conceptos.

La mercancía viajará por cuenta y riesgo del comprador.

Nuestra empresa verifica todos los productos antes de su salida, no aceptando reclamaciones transcurridos 15 días de la fecha de entrega.

— — — — —

Todas las informaciones técnicas, precios y datos varios que figuran en este catálogo son únicamente a título informativo reservándonos el derecho de modificar cualquiera de ellos sin previo aviso.







C/ Can Magí, 20. Polígono Industrial Santiga - Apdo. de Correos 364 / P.O. Box n. 364  
08210 BARBERÀ DEL VALLÈS (Barcelona) ESPAÑA / SPAIN  
Tel. 93 729 99 60 - Fax 93 729 99 61  
e-mail: [hispanox@hispanox.com](mailto:hispanox@hispanox.com) - [www.hispanox.com](http://www.hispanox.com)

